

2024 HDPE, HOSE, FITTINGS, CAMLOCKS AND CLAMPS

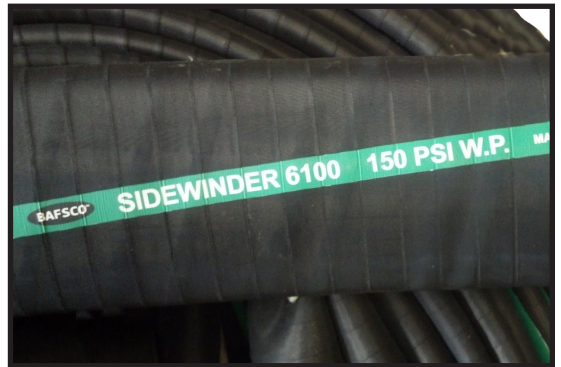

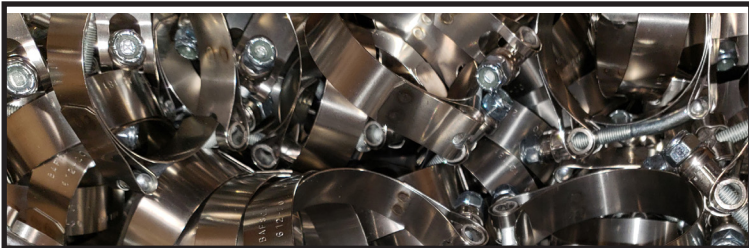

PRESSURE PIPE

| SDR | | 3/4" | 1" | 1 1/4" | 1 1/2" | 2" | 3" | 4" |
|----------|-------|-------|-------|--------|--------|-------|-------|-------|
| 333 PSI | OD | 1.050 | 1.315 | 1.660 | 1.900 | 2.375 | 3.500 | 0.000 |
| | ID | 0.730 | 0.920 | 1.160 | 1.325 | 1.656 | 2.440 | 0.000 |
| SDR7 | WALL | 0.150 | 0.188 | 0.237 | 0.217 | 0.339 | 0.200 | 0.000 |
| | WT/FT | 0.190 | 0.290 | 0.460 | 0.610 | 0.950 | 2.060 | 0.000 |
| 250 PSI | OD | 1.050 | 1.315 | 1.660 | 1.900 | 2.375 | 3.500 | 4.500 |
| | ID | 0.818 | 1.023 | 1.292 | 1.478 | 1.847 | 2.722 | 3.500 |
| SDR9 | WALL | 0.117 | 0.146 | 0.184 | 0.211 | 0.264 | 0.389 | 0.500 |
| | WT/FT | 0.150 | 0.230 | 0.360 | 0.480 | 0.750 | 1.360 | 2.688 |
| 200 PSI | OD | 1.050 | 1.315 | 1.660 | 1.900 | 2.375 | 3.500 | 4.500 |
| | ID | 0.860 | 1.075 | 1.358 | 1.554 | 1.943 | 2.864 | 3.682 |
| SDR11 | WALL | 0.095 | 0.120 | 0.151 | 0.173 | 0.216 | 0.318 | 0.409 |
| | WT/FT | 0.120 | 0.190 | 0.300 | 0.400 | 0.640 | 1.400 | 2.250 |
| 160 PSI | OD | 0.000 | 1.315 | 1.660 | 1.900 | 2.375 | 3.500 | 4.500 |
| | ID | 0.000 | 1.121 | 1.414 | 1.618 | 2.023 | 2.982 | 3.834 |
| SDR 13.5 | WALL | 0.000 | 0.097 | 0.123 | 0.141 | 0.176 | 0.259 | 0.330 |
| | WT/FT | 0.000 | 0.160 | 0.260 | 0.340 | 0.530 | 1.160 | 1.910 |

- IPS
- OD CONTROLLED
- HEAT FUSION READY

Raw Material

Manufactured using only virgin 4710 resin and NSF approved master batch (colorant)

Conformance

NSF 61, ASTM D3035

TURF IRRIGATION

Recommended Application

Turf Irrigation – Lawn Sprinklers

Raw Material

Manufactured using only virgin resin.

Stocking Sizes

Stocking coil sizes include 100' 300' and 500' lengths.

Available Colors

Other colors available upon request.



SPECIFICATIONS

Produced to ASTM D2239 dimensional specifications

| SIDR15 | 3/4" | 1" | 1 1/4" | 1 1/2" | 2" |
|---------|-------|-------|--------|--------|-------|
| ID | 0.824 | 1.049 | 1.380 | 1.610 | 2.067 |
| OD | 0.944 | 1.189 | 1.564 | 1.824 | 2.343 |
| WALL | 0.060 | 0.070 | 0.092 | 0.107 | 0.138 |
| WT / FT | 0.070 | 0.105 | 0.185 | 0.247 | 0.410 |

WATTS® ANKA HIGH PRESSURE POLY-PIPE FITTINGS

- Ideal for agricultural, irrigation, rural and municipal, and plumbing applications.
- Efficiently connects polyethylene pipe, tube, and hose. **Designed for use with all ID (inside diameter) rated pipe**
- Fast and easy to install; Connection can be made by hand, with no special tools required.
- High grade fiberglass reinforced nylon construction offers corrosion resistance and long-lasting, reusable wear
- Provides Leak Free* protection with unique captive self threading nut and is UV stabilized for above ground or below grade applications - Maximum pressure is 230 psi and maximum temperature is 140°



STRAIGHT COUPLING

| PART # | PIPE | INNER/BOX | LIST |
|--------|--------|-----------|-------|
| ASC12 | 1/2" | 10/180 | 5.00 |
| ASC34 | 3/4" | 10/180 | 6.00 |
| ASC1 | 1" | 5/90 | 7.00 |
| ASC114 | 1 1/4" | 5/60 | 11.50 |



REDUCING STRAIGHT COUPLING

| PART # | PIPE | INNER/BOX | LIST |
|----------|-------------|-----------|------|
| ARSC3412 | 3/4" X 1/2" | 10/180 | 6.00 |
| ARSC112 | 1" X 1/2" | 5/90 | 7.00 |
| ARSC134 | 1" X 3/4" | 5/90 | 7.00 |
| ARSC1141 | 1 1/4" X 1" | 5/60 | 8.00 |



MALE ADAPTER

| PART # | PIPE/MPT | INNER/BOX | LIST |
|--------|----------|-----------|------|
| AMA12 | 1/2" | 10/180 | 4.50 |
| AMA34 | 3/4" | 10/180 | 5.00 |
| AMA1 | 1" | 5/60 | 7.25 |
| AMA114 | 1 1/4" | 5/60 | 8.25 |

Designed for use with all ID (inside diameter) rated pipe



REDUCING ADAPTERS

| PART # | PIPE/NPT | INNER/BOX | LIST |
|----------|-------------|-----------|------|
| ARMA1234 | 1/2" x 3/4" | 10/180 | 5.00 |
| ARMA121 | 1/2" x 1" | 5/90 | 6.00 |
| ARMA1114 | 1" x 1/4" | 5/60 | 7.75 |
| ARFA1234 | 1/2" x 3/4" | 10/180 | 4.75 |



FEMALE ADAPTER

| PART # | PIPE | INNER/BOX | LIST |
|--------|--------|-----------|------|
| AFA12 | 1/2" | 10/180 | 4.50 |
| AFA34 | 3/4" | 10/180 | 5.25 |
| AFA1 | 1" | 5/90 | 6.75 |
| AFA114 | 1 1/4" | 5/60 | 8.25 |



TEE

| PART # | PIPE | INNER/BOX | LIST |
|--------|--------|-----------|-------|
| AT12 | 1/2" | 10/180 | 7.00 |
| AT34 | 3/4" | 10/120 | 8.50 |
| AT1 | 1" | 5/60 | 11.00 |
| AT114 | 1 1/4" | 5/45 | 14.00 |

Designed for use with all ID (inside diameter) rated pipe



REDUCING TEE

| PART # | PIPE/RUN | INNER/BOX | LIST |
|---------|-------------|-----------|-------|
| ART3412 | 3/4" x 1/2" | 10/120 | 8.00 |
| ART112 | 1" x 1/2" | 5/60 | 10.00 |
| ART134 | 1" x 3/4" | 5/60 | 11.00 |
| ART1141 | 1 1/4" x 1" | 5/45 | 13.00 |



FEMALE TEE

| PART # | PIPE/NPT | INNER/BOX | LIST |
|---------|-----------|-----------|-------|
| AFT12 | 1/2" | 10/180 | 7.00 |
| AFT34 | 3/4" | 10/120 | 8.00 |
| AFT1 | 1" | 5/60 | 10.00 |
| ARFT134 | 1" x 3/4" | 5/120 | 5.79 |



ELBOW

| PART # | PIPE | INNER/BOX | LIST |
|--------|--------|-----------|-------|
| AE12 | 1/2" | 10/180 | 7.00 |
| AE34 | 3/4" | 10/180 | 8.00 |
| AE1 | 1" | 5/60 | 10.00 |
| AE114 | 1 1/4" | 5/60 | 12.00 |



HIGH PRESSURE POLY-PIPE FITTINGS

Designed for use with all ID (inside diameter) rated pipe



MALE ELBOW

| PART # | PIPE/NPT | INNER/BOX | LIST |
|--------|----------|-----------|-------|
| AME12 | 1/2" | 10/180 | 5.00 |
| AME34 | 3/4" | 10/180 | 6.00 |
| AME1 | 1" | 5/60 | 8.00 |
| AME114 | 1 1/4" | 5/60 | 10.00 |

FEMALE ELBOW

| PART # | PIPE/NPT | INNER/BOX | LIST |
|--------|----------|-----------|-------|
| AFE12 | 1/2" | 10/180 | 5.00 |
| AFE34 | 3/4" | 10/180 | 6.00 |
| AFE1 | 1" | 5/60 | 8.00 |
| AFE114 | 1 1/4" | 5/60 | 10.00 |

REDUCING FEMALE ELBOW

| PART # | PIPE/NPT | INNER/BOX | LIST |
|----------|-------------|-----------|------|
| ARFE3412 | 3/4" x 1/2" | 10/180 | 6.00 |
| ARFE1112 | 1" x 1/2" | 10/120 | 6.00 |
| ARFE134 | 1" x 3/4" | 10/120 | 7.00 |



YARD HYDRANT

| PART # | PIPE/NPT | INNER/BOX | LIST |
|--------|-----------|-----------|------|
| AHF34 | 3/4" | 3/84 | 6.00 |
| AHF134 | 1" x 3/4" | 3/84 | 7.25 |

MALE PUMP UNION

| PART # | PIPE/NPT | INNER/BOX | LIST |
|--------|----------|-----------|-------|
| APU34 | 3/4" | 5/60 | 16.00 |
| APU1 | 1" | 5/60 | 17.00 |
| APU114 | 1 1/4" | 5/60 | 18.00 |

HOSE REEL & TRIGGER GUNS 3/4" GARDEN HOSE THREAD

| PART # | DESC. | INNER/BOX | LIST |
|----------|------------------|-----------|-------|
| AHNS20 | Hose Reel Nozzle | 6/130 | 18.00 |
| AHNT20 | Trigger Gun | 6/94 | 23.00 |
| AHNT20HW | Gun Hot Water | 6/94 | 26.00 |



UNIONS

| PART # | NPT | INNER/BOX | LIST |
|----------|--------|-----------|-------|
| AFU34 | 3/4" | 10/90 | 15.00 |
| AFU1 | 1" | 10/90 | 16.00 |
| AFU114 | 1 1/4" | 5/60 | 21.00 |
| AFU112US | 1 1/2" | 5/60 | 35.00 |
| AFU2US | 2" | 5/45 | 52.00 |

QUICK-LOCK COUPLINGS

| PART # | NPT | INNER/BOX | LIST |
|----------|--------|-----------|-------|
| AQLCF34 | 3/4" | 10/180 | 12.50 |
| AQLCF1 | 1" | 10/180 | 13.50 |
| AQLCF114 | 1 1/4" | 10/120 | 15.00 |
| AQLCF112 | 1 1/2" | 10/120 | 17.00 |
| AQLCM34 | 3/4" | 10/180 | 12.50 |
| AQLCM1 | 1" | 10/180 | 13.50 |
| AQLCM114 | 1 1/4" | 10/120 | 15.00 |
| AQLCM112 | 1 1/2" | 10/120 | 17.00 |

FOOT AND CHECK VALVES

| PART # | PIPE | INNER/BOX | LIST |
|--------|-----------------------|-----------|-------|
| AFV34 | 3/4" | 4/80 | 17.00 |
| AFV1 | 1" | 4/70 | 20.00 |
| AFV114 | 1 1/4" | 4/60 | 21.00 |
| AFV112 | 1 1/2" | 4/40 | 29.00 |
| AFV2 | 2" | 4/25 | 34.00 |
| ACV34 | 3/4" | 4/100 | 16.00 |
| ACV1 | 1" | 4/80 | 20.00 |
| ACV114 | 1 1/4" | 4/50 | 21.00 |
| ACV112 | 1 1/2" | 4/50 | 28.00 |
| ACV2 | 2" | 4/35 | 33.00 |
| FVSOCK | Foot Valve Filter Sck | 10/50 | 21.00 |

WASH DOWN NOZZLES

| PART # | HOSE/FPT | INNER/BOX | LIST |
|-----------|----------|-----------|-------|
| AHNS25-25 | 1" | 6/80 | 22.00 |
| AHNS32-32 | 1 1/4" | 6/65 | 25.25 |
| AHN32-32 | 1 1/4" | 6/45 | 35.00 |
| AHN40-40 | 1 1/2" | 6/45 | 37.00 |

Repair Kits Available



**PHILMAC® IPS-OD COMPRESSION FITTINGS
SDR ASTM D3035, F714 & AWWA C901 HDPE**



COUPLING WITH STOP

| PART # | SIZE | BOX | LIST |
|------------|--------|-----|--------|
| 75-30833 | 3/4" | 100 | 13.75 |
| 75-30844 | 1" | 65 | 20.13 |
| 75-30855 | 1 1/4" | 35 | 33.04 |
| 75-30866 | 1 1/2" | 24 | 40.80 |
| 77-30888 | 2" | 12 | 51.41 |
| 75-3081212 | 3" | 8 | 205.84 |



REPAIR COUPLING NO STOP

| PART # | SIZE | BOX | LIST |
|------------|--------|-----|--------|
| 75-30933 | 3/4" | 100 | 13.75 |
| 75-30944 | 1" | 65 | 20.13 |
| 75-30955 | 1 1/4" | 35 | 33.04 |
| 75-30966 | 1 1/2" | 24 | 40.80 |
| 77-30988 | 2" | 12 | 51.41 |
| 75-3091212 | 3" | 8 | 205.84 |



REDUCER COUPLING

| PART # | SIZE | BOX | LIST |
|----------|-----------------|-----|--------|
| 75-31743 | 1" x 3/4" | 70 | 25.99 |
| 75-31753 | 1 1/4" x 3/4" | 50 | 47.44 |
| 75-31754 | 1 1/4" x 1" | 40 | 48.99 |
| 75-31763 | 1 1/2" x 3/4" | 30 | 65.73 |
| 75-31764 | 1 1/2" x 1" | 30 | 72.64 |
| 75-31765 | 1 1/2" x 1 1/4" | 25 | 73.88 |
| 77-31784 | 2" x 1" | 20 | 90.19 |
| 77-31785 | 2" x 1 1/4" | 20 | 97.50 |
| 77-31886 | 2" x 1 1/2" | 16 | 100.46 |



**FEMALE ADAPTER
COMPRESSION X FNPT**

| PART # | SIZE | BOX | LIST |
|----------|-----------------|-----|-------|
| 75-33232 | 3/4" x 1/2" | 150 | 30.14 |
| 75-33233 | 3/4" | 150 | 17.44 |
| 75-33242 | 1" x 1/2" | 80 | 30.48 |
| 75-33243 | 1" x 3/4" | 80 | 30.38 |
| 75-33244 | 1" | 80 | 17.76 |
| 75-33245 | 1" x 1 1/4" | 75 | 23.83 |
| 75-33252 | 1 1/4" x 1/2" | 50 | 46.89 |
| 75-33253 | 1 1/4" x 3/4" | 50 | 46.89 |
| 75-33254 | 1 1/4" x 1" | 50 | 46.89 |
| 75-33255 | 1 1/4" | 50 | 26.25 |
| 75-33262 | 1 1/2" x 1/2" | 35 | 51.96 |
| 75-33263 | 1 1/2" x 3/4" | 35 | 51.96 |
| 75-33264 | 1 1/2" x 1" | 35 | 51.96 |
| 75-33265 | 1 1/2" x 1 1/4" | 35 | 51.96 |
| 75-33266 | 1 1/2" | 35 | 31.31 |
| 77-33282 | 2" x 1/2" | 20 | 65.11 |
| 77-33283 | 2" x 3/4" | 20 | 65.11 |
| 77-33284 | 2" x 1" | 20 | 65.11 |
| 77-33285 | 2" x 1 1/4" | 20 | 65.11 |
| 77-33286 | 2" x 1 1/2" | 20 | 65.11 |
| 77-33288 | 2" | 20 | 44.12 |



**SERVICE ELBOW
COMPRESSION X FNPT**

| PART # | SIZE | BOX | LIST |
|----------|-----------------|-----|-------|
| 75-32032 | 3/4" x 1/2" | 150 | 28.59 |
| 75-32033 | 3/4" | 150 | 15.89 |
| 75-32034 | 3/4" x 1" | 110 | 15.89 |
| 75-32042 | 1" x 1/2" | 75 | 41.10 |
| 75-32043 | 1" x 3/4" | 75 | 41.10 |
| 75-32044 | 1" | 75 | 28.40 |
| 75-32052 | 1 1/4" x 1/2" | 45 | 73.86 |
| 75-32053 | 1 1/4" x 3/4" | 45 | 73.86 |
| 75-32054 | 1 1/4" x 1" | 45 | 73.86 |
| 75-32055 | 1 1/4" | 45 | 53.21 |
| 75-32056 | 1 1/4" x 1 1/2" | 45 | 53.21 |
| 75-32062 | 1 1/2" x 1/2" | 30 | 85.96 |
| 75-32063 | 1 1/2" x 3/4" | 30 | 85.96 |
| 75-32064 | 1 1/2" x 1" | 30 | 85.96 |
| 75-32065 | 1 1/2" x 1 1/4" | 30 | 85.96 |
| 75-32066 | 1 1/2" | 30 | 65.31 |
| 77-32082 | 2" x 1/2" | 18 | 87.29 |
| 77-32083 | 2" x 3/4" | 18 | 87.29 |
| 77-32084 | 2" x 1" | 18 | 87.29 |
| 77-32085 | 2" x 1 1/4" | 18 | 87.29 |
| 77-32086 | 2" x 1 1/2" | 18 | 87.29 |
| 77-32088 | 2" | 18 | 65.32 |



**MALE ADAPTER
COMPRESSION X MNPT**

| PART # | SIZE | BOX | LIST |
|----------|-------------|-----|-------|
| 75-33033 | 3/4" | 150 | 9.68 |
| 75-33043 | 1" x 3/4" | 90 | 12.54 |
| 75-33044 | 1" | 90 | 12.54 |
| 75-33054 | 1 1/4" x 1" | 55 | 19.85 |
| 75-33055 | 1 1/4" | 55 | 19.85 |
| 75-33066 | 1 1/2" | 35 | 23.65 |
| 77-33088 | 2" | 22 | 29.51 |



90° ELBOW

| PART # | SIZE | BOX | LIST |
|------------|--------|-----|--------|
| 75-31833 | 3/4" | 80 | 20.10 |
| 75-31844 | 1" | 50 | 20.59 |
| 75-31855 | 1 1/4" | 30 | 36.41 |
| 75-31866 | 1 1/2" | 18 | 48.29 |
| 77-31888 | 2" | 10 | 57.23 |
| 75-3181212 | 3" | 3 | 216.24 |

**PHILMAC® IPS-OD COMPRESSION FITTINGS
SDR ASTM D3035, F714 & AWWA C901 HDPE**



| TEE | | | |
|-------------|--------|-----|--------|
| PART # | SIZE | BOX | LIST |
| 75-312333 | 3/4" | 50 | 28.04 |
| 75-312444 | 1" | 30 | 28.48 |
| 75-312555 | 1 1/4" | 18 | 49.71 |
| 75-312666 | 1 1/2" | 12 | 63.46 |
| 77-312888 | 2" | 8 | 86.04 |
| 75-33121212 | 3" | 3 | 341.76 |

| REDUCING TEE | | | |
|--------------|-----------------|-----|--------|
| PART # | SIZE | BOX | LIST |
| 75-313443 | 1" x 3/4" | 30 | 56.04 |
| 75-313553 | 1 1/4" x 3/4" | 20 | 71.36 |
| 75-313663 | 1 1/2" x 3/4" | 16 | 98.69 |
| 75-313664 | 1 1/2" x 1" | 16 | 98.69 |
| 75-313665 | 1 1/2" x 1 1/4" | 12 | 107.63 |
| 77-313884 | 2" x 1" | 10 | 101.76 |
| 77-313886 | 2" x 1 1/2" | 9 | 130.68 |

| END CAP | | | |
|----------|--------|-----|--------|
| PART # | SIZE | BOX | LIST |
| 75-3493 | 3/4" | 160 | 12.79 |
| 75-3494 | 1" | 100 | 16.30 |
| 75-3495 | 1 1/4" | 55 | 24.19 |
| 75-3496 | 1 1/2" | 35 | 33.69 |
| 77-3498 | 2" | 20 | 41.17 |
| 75-34912 | 3" | 4 | 166.44 |



| SERVICE TEE COMPRESSION X FNPT | | | |
|-----------------------------------|-----------------|-----|-------|
| PART # | SIZE | BOX | LIST |
| 75-351332 | 3/4" x 1/2" | 60 | 38.71 |
| 75-351333 | 3/4" | 60 | 26.00 |
| 75-351334 | 3/4" x 1" | 60 | 28.05 |
| 75-351442 | 1" x 1/2" | 50 | 29.89 |
| 75-351443 | 1" x 3/4" | 45 | 29.89 |
| 75-351444 | 1" | 40 | 29.89 |
| 75-351552 | 1 1/4" x 1/2" | 20 | 60.54 |
| 75-351553 | 1 1/4" x 3/4" | 20 | 60.54 |
| 75-351554 | 1 1/4" x 1" | 20 | 60.54 |
| 75-351555 | 1 1/4" | 20 | 39.89 |
| 75-351662 | 1 1/2" x 1/2" | 20 | 49.44 |
| 75-351663 | 1 1/2" x 3/4" | 18 | 49.44 |
| 75-351664 | 1 1/2" x 1" | 15 | 70.09 |
| 75-351665 | 1 1/2" x 1 1/4" | 15 | 70.09 |
| 75-351666 | 1 1/2" | 15 | 49.44 |
| 77-351882 | 2" x 1/2" | 9 | 71.23 |
| 77-351883 | 2" x 3/4" | 9 | 71.23 |
| 77-351884 | 2" x 1" | 9 | 71.23 |
| 77-351885 | 2" x 1 1/4" | 9 | 71.23 |
| 77-351886 | 2" x 1 1/2" | 9 | 71.23 |
| 77W-351888 | 2" | 9 | 49.97 |



| PLUG | | | |
|---------|--------|-----|------|
| PART # | SIZE | BOX | LIST |
| 75-6983 | 3/4" | 250 | 4.93 |
| 75-6984 | 1" | 180 | 5.85 |
| 75-6985 | 1 1/4" | 150 | 6.88 |
| 75-6986 | 1 1/2" | 100 | 7.55 |



| BALL VALVE WITH TEE HANDLE | | | |
|----------------------------|--------|-----|--------|
| PART # | SIZE | BOX | LIST |
| 76-30103 | 3/4" | 33 | 79.21 |
| 76-30104 | 1" | 25 | 83.44 |
| 76-30105 | 1 1/4" | 14 | 107.09 |
| 76-30106 | 1 1/2" | 10 | 138.18 |
| 76-30108 | 2" | | 193.75 |



| INSTALL TOOL | | | |
|--------------|--------|-----|-------|
| PART # | SIZE | BOX | LIST |
| 75-3023 | 3/4" | 1 | 72.68 |
| 75-3024 | 1" | 1 | 72.68 |
| 75-3025 | 1 1/4" | 1 | 72.68 |
| 75-3026 | 1 1/2" | 1 | 72.68 |
| 77-3028 | 2" | 1 | 72.68 |



| VALVE W/ CURB STOP HANDLE | | | |
|---------------------------|--------|-----|--------|
| PART # | SIZE | BOX | LIST |
| 76-30203 | 3/4" | | 121.75 |
| 76-30205 | 1 1/4" | 13 | 241.43 |
| 76-30206 | 1 1/2" | 9 | 287.05 |
| 76-30208 | 2" | | 313.95 |

**PHILMAC® 3G IPS-ID COMPRESSION FITTINGS
SIDR ASTM D2239, AWWA C901 HDPE**



COUPLING WITH STOP

| PART # | SIZE | BOX | LIST |
|----------|--------|-----|-------|
| 75-20833 | 3/4" | 80 | 19.60 |
| 75-20844 | 1" | 40 | 26.50 |
| 75-20855 | 1 1/4" | 25 | 46.09 |
| 75-20866 | 1 1/2" | 15 | 52.13 |
| 75-20888 | 2" | 10 | 69.56 |

REDUCER COUPLING

| PART # | SIZE | BOX | LIST |
|----------|-----------------|-----|-------|
| 75-21743 | 1" x 3/4" | 60 | 26.08 |
| 75-21754 | 1 1/4" x 1" | 40 | 50.24 |
| 75-21765 | 1 1/2" x 1 1/4" | 20 | 56.75 |
| 75-21784 | 2" x 1" | 15 | 63.99 |
| 75-21785 | 2" x 1 1/4" | 12 | 64.58 |
| 75-21786 | 2" x 1 1/2" | 12 | 66.16 |

END CAP

| PART # | SIZE | BOX | LIST |
|---------|--------|-----|-------|
| 75-2493 | 3/4" | 130 | 10.49 |
| 75-2494 | 1" | 70 | 15.61 |
| 75-2495 | 1 1/4" | 50 | 25.05 |
| 75-2496 | 1 1/2" | 35 | 29.18 |
| 75-2498 | 2" | 20 | 31.18 |



**FEMALE ADAPTER
COMPRESSION X FNPT**

| PART # | SIZE | BOX | LIST |
|----------|--------|-----|-------|
| 75-23233 | 3/4" | 120 | 19.54 |
| 75-23244 | 1" | 60 | 23.95 |
| 75-23255 | 1 1/4" | 50 | 39.63 |
| 75-23266 | 1 1/2" | 35 | 45.74 |
| 75-23288 | 2" | 18 | 42.06 |



**ELBOW
COMPRESSION**

| PART # | SIZE | BOX | LIST |
|----------|--------|-----|--------|
| 75-21833 | 3/4" | 70 | 19.48 |
| 75-21844 | 1" | 40 | 27.00 |
| 75-21855 | 1 1/4" | 30 | 50.08 |
| 75-21866 | 1 1/2" | 14 | 111.86 |
| 75-21888 | 2" | 8 | 83.23 |



**SERVICE TEE
COMPRESSION X FNPT**

| PART # | SIZE | BOX | LIST |
|-----------|--------|-----|-------|
| 75-251333 | 3/4" | 60 | 35.93 |
| 75-251444 | 1" | 25 | 53.79 |
| 75-251555 | 1 1/4" | | 72.00 |
| 75-251666 | 1 1/2" | | 81.55 |
| 75-251888 | 2" | | 87.78 |



**MALE ADAPTER
COMPRESSION X MNPT**

| PART # | SIZE | BOX | LIST |
|----------|-------------|-----|-------|
| 75-23033 | 3/4" | 130 | 13.11 |
| 75-23044 | 1" | 70 | 16.19 |
| 75-23055 | 1 1/4" | 50 | 27.04 |
| 75-23066 | 1 1/2" | 30 | 29.91 |
| 75-23068 | 1 1/2" x 2" | 30 | 30.94 |
| 75-23086 | 2" x 1 1/2" | | 84.13 |
| 75-23088 | 2" | 18 | 33.66 |



**ELBOW ADAPTER
COMPRESSION X FNPT**

| PART # | SIZE | BOX | LIST |
|----------|--------|-----|-------|
| 75-22033 | 3/4" | 210 | 25.40 |
| 75-22044 | 1" | 55 | 25.79 |
| 75-22055 | 1 1/4" | 35 | 38.48 |
| 75-22066 | 1 1/2" | 30 | 52.48 |
| 75-22088 | 2" | 18 | 60.11 |

Ball Valves & Curb Stop Valves Available



**TEE
COMPRESSION**

| PART # | SIZE | BOX | LIST |
|-----------|-------------|-----|-------|
| 75-212333 | 3/4" | 40 | 26.78 |
| 75-212444 | 1" | 25 | 37.79 |
| 75-212555 | 1 1/4" | 20 | 69.38 |
| 75-212666 | 1 1/2" | 10 | 80.95 |
| 75-212884 | 2" x 1" | | 77.10 |
| 75-212886 | 2" x 1 1/2" | | 85.88 |
| 75-212888 | 2" | | 87.78 |

PHILMAC® BALL VALVES AND UTC COUPLING



IPS-ID PLUG

| PART # | SIZE | BOX | LIST |
|---------|----------|-----|-------|
| 75-6983 | 3/4"/3 | 250 | 4.93 |
| 75-6984 | 1 1/4 | 80 | 5.85 |
| 75-6985 | 1 1/4"/5 | 150 | 6.88 |
| 75-6986 | 1 1/2"/6 | 100 | 7.55 |
| 75-6988 | 2"/7 | 80 | 11.21 |



BALL VALVE IPS-ID

| PART # | SIZE | BOX | LIST |
|----------|--------|-----|--------|
| 76-20103 | 3/4" | | 98.18 |
| 76-20104 | 1" | | 103.14 |
| 76-20105 | 1 1/4" | | 115.43 |
| 76-20106 | 1 1/2" | | 167.99 |
| 76-20108 | 2" | | 187.19 |



BALL VALVE IPS-ID

| PART # | SIZE | BOX | LIST |
|----------|--------|-----|--------|
| 76-20203 | 3/4" | | 140.73 |
| 76-20205 | 1 1/4" | | 249.76 |
| 76-20206 | 1 1/2" | | 316.87 |
| 76-20208 | 2" | | 343.76 |



FPT BALL VALVE W/TEE HANDLE

| PART # | SIZE | BOX | LIST |
|---------|--------|-----|--------|
| 76-2493 | 3/4" | 80 | 57.52 |
| 76-2494 | 1" | 60 | 65.97 |
| 76-2495 | 1 1/4" | 35 | 81.91 |
| 76-2496 | 1 1/2" | 26 | 95.27 |
| 76-2498 | 2" | 20 | 114.83 |

MPT x MPT and MPT x FPT Available in 2"



BALL VALVE CTS-OD

| PART # | SIZE | BOX | LIST |
|----------|--------|-----|--------|
| 76-10103 | 3/4" | | 79.21 |
| 76-10104 | 1" | | 84.54 |
| 76-10105 | 1 1/4" | | 96.15 |
| 76-10106 | 1 1/2" | | 112.52 |
| 76-10108 | 2" | | 178.74 |

Tee Handle



BALL VALVE CTS-OD

| PART # | SIZE | BOX | LIST |
|----------|--------|-----|--------|
| 76-10203 | 3/4" | | 126.46 |
| 76-10205 | 1" | | 127.06 |
| 76-10206 | 1 1/2" | | 246.84 |
| 76-10208 | 2" | | 308.21 |

Curb Stop Handle



UTC TRANSITION COUPLING

| PART # | SIZE | BOX | LIST |
|----------|----------------|-----|--------|
| 75-608AA | A, 0.59"-0.83" | | 37.76 |
| 75-608BB | B, 0.83"-1.06" | 50 | 40.30 |
| 75-608CC | C, 1.06"-1.34" | 25 | 58.55 |
| 75-608DD | D, 1.34"-1.54" | 25 | 73.83 |
| 75-608EE | E, 1.54"-1.69" | 20 | 67.00 |
| 75-608FF | F, 1.86"-1.93" | 15 | 103.21 |
| 75-608GG | G, 2.32"-2.40" | 10 | 128.11 |

UTC® SELECTION RECOMMENDATIONS

| PIPE MATERIALS ^d | ASTM STANDARD | 1/2" | 5/8" | 3/4" | 1" | 1 1/4" | 1 1/2" | 2" |
|-----------------------------------|--------------------|------|------|---------------------------------|--------------------|--------|----------------|----|
| Copper (Type K, L, & M) | B88 | A | na | B | C | D | E | na |
| CTS PE or PEX | D2737 / F876 | A | na | B | C | D | E | na |
| PVC (IPS-OD) | D2241 / D1785 | B | na | B ^a & C | C ^a & D | E | F | G |
| ABS (IPS-OD) | D1527/ D2661/ F628 | B | na | B ^a & C | C ^a & D | E | F | G |
| Galvanized Steel / Steel (IPS-OD) | A53 | B | na | B ^a & C | C ^a & D | E | F | G |
| Stainless Steel ^c | A312 / A358 / A376 | B | na | B ^a & C | C ^a & D | E | F | G |
| PE IPS-OD (SDR) | D3035 / D2447 | B | na | B ^a & C | C ^a & D | E | F | G |
| PE SIDR 7 (IPS-ID) | D2239 | na | na | C | D | na | na | na |
| PE SIDR 9 (IPS-ID) | D2239 | A | na | B | C | na | na | na |
| PE SIDR 11.5 (IPS-ID) | D2239 | A | na | B | C | E | F ^a | na |
| PE SIDR 15 (IPS-ID) | D2239 | A | na | B | C | E | na | G |
| Lead Strong | | A | B | C | D | E | na | na |
| Extra Strong | | B | C | C | D | na | na | na |
| Double Extra Strong ^b | | B | C | C ^b & D ^b | E | F | na | na |

PHILMAC® 3G CTS-OD COMPRESSION FITTINGS
ASTM D2737/AWWA C901 PE, AWWA C904/ASTM F876 PEX



COUPLING WITH STOP

| PART # | SIZE | BOX | LIST |
|----------|--------|-----|-------|
| 75-10833 | 3/4" | 150 | 13.85 |
| 75-10844 | 1" | 90 | 17.36 |
| 75-10855 | 1 1/4" | 65 | 25.41 |
| 75-10866 | 1 1/2" | 35 | 41.69 |
| 75-10888 | 2" | 24 | 51.55 |



REPAIR COUPLING NO STOP

| PART # | SIZE | BOX | LIST |
|----------|--------|-----|-------|
| 75-10933 | 3/4" | 150 | 13.85 |
| 75-10944 | 1" | 90 | 17.36 |
| 75-10955 | 1 1/4" | 65 | 25.41 |
| 75-10966 | 1 1/2" | 35 | 41.69 |
| 75-10988 | 2" | 24 | 51.55 |



REDUCER COUPLING

| PART # | SIZE | BOX | LIST |
|----------|-----------------|-----|--------|
| 75-11743 | 1" x 3/4" | 120 | 15.61 |
| 75-11754 | 1 1/4" x 1" | 70 | 21.11 |
| 75-11765 | 1 1/2" x 1 1/4" | 40 | 41.39 |
| 75-11786 | 2" x 1 1/2" | | 100.49 |



FEMALE ADAPTER
 COMPRESSION X FNPT

| PART # | SIZE | BOX | LIST |
|----------|-----------------|-----|-------|
| 75-13233 | 3/4" | 220 | 18.06 |
| 75-13243 | 1" x 3/4" | 150 | 19.08 |
| 75-13244 | 1" | 130 | 19.35 |
| 75-13254 | 1 1/4" x 1" | 80 | 24.14 |
| 75-13255 | 1 1/4" | 75 | 40.95 |
| 75-13265 | 1 1/2" x 1 1/4" | 50 | 38.55 |
| 75-13266 | 1 1/2" | 50 | 56.25 |
| 75-13288 | 2" | 35 | 74.98 |



ELBOW
 COMPRESSION

| PART # | SIZE | BOX | LIST |
|----------|--------|-----|-------|
| 75-11833 | 3/4" | 140 | 14.51 |
| 75-11844 | 1" | 80 | 17.24 |
| 75-11855 | 1 1/4" | 50 | 25.95 |
| 75-11866 | 1 1/2" | 30 | 45.98 |
| 75-11888 | 2" | 18 | 60.96 |



TEE
 COMPRESSION

| PART # | SIZE | BOX | LIST |
|-----------|--------|-----|--------|
| 75-112333 | 3/4" | 90 | 19.19 |
| 75-112444 | 1" | 50 | 23.25 |
| 75-112555 | 1 1/4" | 30 | 36.04 |
| 75-112666 | 1 1/2" | 18 | 62.79 |
| 75-112888 | 2" | 1 | 103.56 |



MALE ADAPTER
 COMPRESSION X MNPT

| PART # | SIZE | BOX | LIST |
|----------|-----------------|-----|-------|
| 75-13033 | 3/4" | 240 | 10.05 |
| 75-13043 | 1" x 3/4" | 150 | 12.23 |
| 75-13044 | 1" | 150 | 12.64 |
| 75-13054 | 1 1/4" x 1" | 90 | 15.85 |
| 75-13055 | 1 1/4" | 90 | 17.41 |
| 75-13065 | 1 1/2" x 1 1/4" | 55 | 25.11 |
| 75-13066 | 1 1/2" | 55 | 25.11 |
| 75-13086 | 2" x 1 1/2" | 35 | 29.85 |
| 75-13088 | 2" | 32 | 30.28 |



ELBOW ADAPTER
 COMPRESSION X FNPT

| PART # | SIZE | BOX | LIST |
|----------|-----------------|-----|-------|
| 75-12033 | 3/4" | 190 | 20.78 |
| 75-12043 | 1" x 3/4" | 120 | 25.31 |
| 75-12044 | 1" | 110 | 22.26 |
| 75-12054 | 1 1/4" x 1" | 75 | 26.09 |
| 75-12055 | 1 1/4" | 70 | 39.45 |
| 75-12065 | 1 1/2" x 1 1/4" | 45 | 41.11 |
| 75-12066 | 1 1/2" | 45 | 40.38 |
| 75-12088 | 2" | 26 | 74.16 |



SERVICE TEE
 COMPRESSION X FNPT

| PART # | SIZE | BOX | LIST |
|-----------|-----------------|-----|-------|
| 75-151333 | 3/4" | 110 | 29.93 |
| 75-151443 | 1" x 3/4" | 60 | 34.81 |
| 75-151444 | 1" | 60 | 27.81 |
| 75-151554 | 1 1/4" x 1" | 40 | 54.53 |
| 75-151555 | 1 1/4" | 35 | 47.28 |
| 75-151665 | 1 1/2" x 1 1/4" | 20 | 70.78 |
| 75-151666 | 1 1/2" | 20 | 70.98 |
| 75-151888 | 15 | 15 | 73.29 |

PVC INSERT FITTINGS

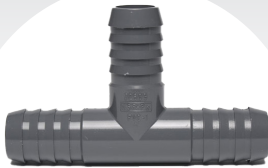

| TEE | | | |
|----------|--------|---------|-------|
| PART # | SIZE | BAG/BOX | LIST |
| 1401-007 | 3/4" | 10/200 | 4.15 |
| 1401-010 | 1" | 10/50 | 5.40 |
| 1401-012 | 1 1/4" | 10/50 | 8.45 |
| 1401-015 | 1 1/2" | 5/25 | 9.55 |
| 1401-020 | 2" | 5/20 | 18.80 |



| ELBOW | | | |
|----------|--------|--------|------|
| PART # | SIZE | BOX | LIST |
| 1406-007 | 3/4" | 10/250 | 4.30 |
| 1406-010 | 1" | 10/100 | 4.75 |
| 1406-012 | 1 1/4" | 5/50 | 5.30 |
| 1406-015 | 1 1/2" | 5/50 | 6.25 |
| 1406-020 | 2" | 5/25 | 8.70 |



| COUPLING | | | |
|----------|--------|--------|------|
| PART # | SIZE | BOX | LIST |
| 1429-007 | 3/4" | 10/250 | 2.15 |
| 1429-010 | 1" | 10/100 | 2.25 |
| 1429-012 | 1 1/4" | 10/100 | 3.30 |
| 1429-015 | 1 1/2" | 10/50 | 3.95 |
| 1429-020 | 2" | 5/25 | 7.40 |



| REDUCING TEE | | | |
|--------------|-----------------|--------|-------|
| PART # | SIZE | BOX | LIST |
| 1401-131 | 1" x 3/4" | 10/100 | 5.55 |
| 1401-167 | 1 1/4" x 3/4" | 10/50 | 7.20 |
| 1401-168 | 1 1/4" x 1" | 10/50 | 7.20 |
| 1401-211 | 1 1/2" x 1" | 10/50 | 12.60 |
| 1401-212 | 1 1/2" x 1 1/4" | 5/25 | 12.60 |
| 1401-251 | 2" x 1 1/2" | 5/25 | 19.25 |



| ELBOW X FPT | | | |
|-------------|--------|--------|-------|
| PART # | SIZE | BOX | LIST |
| 1407-007 | 3/4" | 10/250 | 4.30 |
| 1407-010 | 1" | 10/100 | 5.50 |
| 1407-012 | 1 1/4" | 5/50 | 8.15 |
| 1407-015 | 1 1/2" | 5/50 | 9.25 |
| 1407-020 | 2" | 5/25 | 15.60 |



| MALE ADAPTER | | | |
|--------------|--------|--------|------|
| PART # | SIZE | BOX | LIST |
| 1436-007 | 3/4" | 10/200 | 2.15 |
| 1436-010 | 1" | 10/100 | 2.25 |
| 1436-012 | 1 1/4" | 5/50 | 3.50 |
| 1436-015 | 1 1/2" | 5/50 | 3.95 |
| 1436-020 | 2" | 5/25 | 7.50 |



| REDUCING TEE FPT | | | |
|------------------|-----------------|--------|-------|
| PART # | SIZE | BOX | LIST |
| 1402-131 | 1" x 3/4" | 10/100 | 6.80 |
| 1402-167 | 1 1/4" x 3/4" | 10/50 | 10.20 |
| 1402-168 | 1 1/4" x 1" | 10/50 | 10.80 |
| 1402-211 | 1 1/2" x 1" | 10/50 | 16.85 |
| 1402-212 | 1 1/2" x 1 1/4" | 5/225 | 17.30 |
| 1402-249 | 2" x 1" | 5/25 | 22.15 |
| 1402-251 | 2" x 1 1/2" | 5/25 | 23.20 |



| ELBOW X MPT | | | |
|-------------|--------|--------|-------|
| PART # | SIZE | BOX | LIST |
| 1413-007 | 3/4" | 10/250 | 6.10 |
| 1413-010 | 1" | 10/100 | 8.00 |
| 1413-012 | 1 1/4" | 5/50 | 10.60 |
| 1413-015 | 1 1/2" | 5/50 | 14.05 |
| 1413-020 | 2" | 5/25 | 22.20 |



| FEMALE ADAPTER | | | |
|----------------|--------|--------|-------|
| PART # | SIZE | BOX | LIST |
| 1435-007 | 3/4" | 10/250 | 8.45 |
| 1435-010 | 1" | 10/250 | 9.40 |
| 1435-012 | 1 1/4" | 5/50 | 11.50 |
| 1435-015 | 1 1/2" | 5/50 | 14.60 |
| 1435-020 | 2" | 5/25 | 24.65 |

PVC SUCTION HOSE

SPIRALITE® 115 PVC CLEAR STANDARD SUCTION

Heavy-duty PVC suction hose for use in construction dewatering, liquid waste, cesspool cleaning, septic handling, agricultural applications, and marine use. 3/4" - 12". -10F TO +130F Made in U.S.A.



| PART # | DESCRIPTION | O.D. | P.S.I W.P. | BEND RADIUS | CUT \$/FT. | ROLL \$/FT. |
|----------|--------------------------------------|-------|------------|-------------|------------|-------------|
| 3025-100 | 1" x 100' Clear Cover Reinforced | 1.27" | 100 | 3.0 | 2.06 | 1.75 |
| 3025-125 | 1 1/4" x 100' Clear Cover Reinforced | 1.53" | 90 | 4.0 | 2.71 | 2.30 |
| 3025-150 | 1 1/2" x 100' Clear Cover Reinforced | 1.82" | 90 | 5.0 | 2.77 | 2.35 |
| 3025-200 | 2" x 100' Clear Cover Reinforced | 2.36" | 70 | 7.0 | 4.29 | 3.65 |
| 3025-300 | 3" x 100' Clear Cover Reinforced | 3.44" | 55 | 10.0 | 7.00 | 5.95 |
| 3025-400 | 4" x 100' Clear Cover Reinforced | 4.52" | 50 | 15.0 | 12.30 | 10.45 |
| 3025-600 | 6" x 100' Clear Cover Reinforced | 6.80" | 45 | 30.0 | 23.12 | 19.65 |

SPIRALITE® 113 PVC SPECIAL GREEN STANDARD SUCTION HOSE

Heavy-duty PVC suction hose for use in construction dewatering, liquid waste, cesspool cleaning, septic handling, agricultural applications, and marine use. -10F TO +130F. 3/4" - 8" Made in U.S.A.

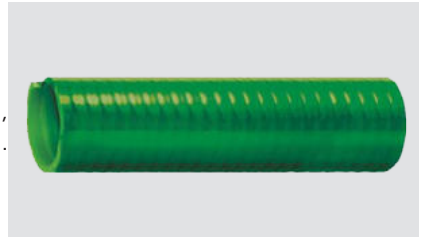

| PART # | DESCRIPTION | O.D. | P.S.I W.P. | BEND RADIUS | CUT \$/FT. | ROLL \$/FT. |
|----------|--------------------------------------|-------|------------|-------------|------------|-------------|
| 3510-100 | 1" x 100' Green Cover Reinforced | 1.27" | 85 | 3.0 | 2.06 | 1.75 |
| 3510-150 | 1 1/2" x 100' Green Cover Reinforced | 1.82" | 70 | 5.0 | 2.71 | 2.30 |
| 3510-200 | 2" x 100' Green Cover Reinforced | 2.36" | 65 | 7.0 | 4.29 | 3.65 |
| 3510-300 | 3" x 100' Green Cover Reinforced | 3.44" | 60 | 10.0 | 7.00 | 5.95 |
| 3510-400 | 4" x 100' Green Cover Reinforced | 4.52" | 50 | 15.0 | 12.30 | 10.45 |
| 3510-600 | 6" x 100' Green Cover Reinforced | 6.80" | 40 | 30.0 | 23.12 | 19.65 |

SPIRALITE® 6200 BRAIDED CLEAR PVC CORRUGATED HOSE

Heavy duty PVC suction and discharge hose designed for applications requiring combined vacuum and higher working pressures. Excellent for use as a fish suction hose and for rental/construction pumping. Clear sidewall allows for easy inspection of material flow and external helix provides for easy drag. -10F TO +130F. 1" - 12" Made in U.S.A.

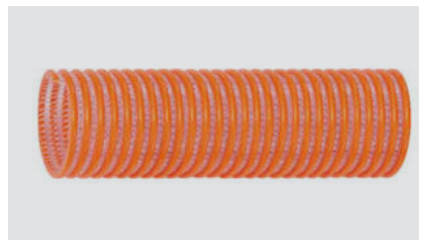

| PART # | DESCRIPTION | O.D. | P.S.I W.P. | BEND RADIUS | CUT \$/FT. | ROLL \$/FT. |
|----------|--|-------|------------|-------------|------------|-------------|
| 3580-150 | 1 1/2" x 100' Clear PVC w/ Orange Helix Braided Reinforced | 1.88" | 100 | 4.0 | 7.94 | 6.75 |
| 3580-200 | 2" x 100' Clear PVC w/ Orange Helix Braided Reinforced | 2.41" | 100 | 5.0 | 9.59 | 8.15 |
| 3580-300 | 3" x 100' Clear PVC w/ Orange Helix Braided Reinforced | 3.54" | 100 | 7.0 | 11.35 | 9.65 |
| 3580-400 | 4" x 100' Clear PVC w/ Orange Helix Braided Reinforced | 4.65" | 75 | 8.0 | 16.88 | 14.35 |
| 3580-600 | 6" x 100' Clear PVC w/ Orange Helix Braided Reinforced | 6.86" | 70 | 12.0 | 34.60 | 29.40 |
| 3580-800 | 8" x 100' Clear PVC w/ Orange Helix Braided Reinforced | 9.10" | 50 | 30.0 | 59.94 | 50.95 |

PVC SUCTION HOSE

SPIRALITE® EPDM SUCTION HOSE

Black EPDM rubber tube with natural polyethylene helix. Corrugated wall, smooth interior. Excellent flexibility and durability with good chemical resistance. Solid EPDM Rubber ensures seamless flow and maximum durability. Polyethylene helix allows easy handling and resists abrasion, Also available with GREEN helix. Resistant to light chemical and fertilizer solutions. TEMPERATURE RANGE: -30F TO +140F

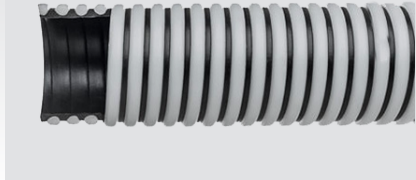

| PART # | DESCRIPTION | O.D. | P.S.I W.P. | BEND RADIUS | CUT \$/FT. | ROLL \$/FT. |
|----------|--|-------|------------|-------------|------------|-------------|
| 3680-100 | 1" x 100' EPDM Suction Hose w/Polyethylene Helix | 1.34" | 50 | 4.0 | 3.59 | 3.05 |
| 3680-150 | 1 1/2" x 100' EPDM Suction Hose w/Polyethylene Helix | 1.96" | 50 | 6.0 | 4.65 | 3.95 |
| 3680-200 | 2" x 100' EPDM Suction Hose w/Polyethylene Helix | 2.49" | 50 | 9.0 | 6.76 | 5.75 |
| 3680-300 | 3" x 100' EPDM Suction Hose w/Polyethylene Helix | 3.60" | 50 | 12.0 | 22.60 | 10.85 |
| 3680-400 | 4" x 100' EPDM Suction Hose w/Polyethylene Helix | 4.69" | 45 | 17.0 | 22.35 | 19.00 |
| 3680-600 | 6" x 100' EPDM Suction Hose w/Polyethylene Helix | 6.86" | 35 | 27.0 | 40.29 | 34.25 |

SPIRALITE® PVC CLEAR BRAIDED TUBING

Clear PVC tube with braided reinforcement. Non-toxic food-grade formula. Can be used for transferring liquids, air and food processing. Suitable for use in USDA meat and poultry plants. TEMPERATURE RANGE: -10F TO +130F

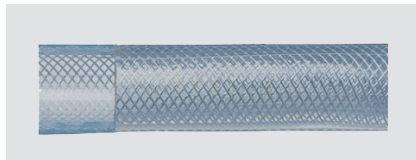

| PART # | DESCRIPTION | I.D. | O.D. | P.S.I W.P. | CUT \$/FT. | ROLL \$/FT. |
|----------|--|-------|-------|------------|------------|-------------|
| 3410-025 | 1/4" x 300' PVC Clear Braided Tubing | .258" | .469" | 250 | .70 | .60 |
| 3410-038 | 3/8" x 300' PVC Clear Braided Tubing | .383" | .625" | 200 | 1.06 | .90 |
| 3410-050 | 1/2" x 300' PVC Clear Braided Tubing | .516" | .750" | 200 | 1.41 | 1.20 |
| 3410-062 | 5/8" x 300' PVC Clear Braided Tubing | .632" | .875" | 200 | 1.88 | 1.60 |
| 3410-075 | 3/4" x 300' PVC Clear Braided Tubing | .766" | 1.03" | 150 | 2.29 | 1.95 |
| 3410-100 | 1" x 100' PVC Clear Braided Tubing | 1.00" | 1.54" | 125 | 3.23 | 2.75 |
| 3410-125 | 1 1/4" x 100' PVC Clear Braided Tubing | 1.25" | 1.75" | 100 | 7.00 | 5.95 |
| 3410-150 | 1 1/2" x 100' PVC Clear Braided Tubing | 1.50" | 2" | 75 | 9.00 | 7.65 |
| 3410-200 | 2" x 100' PVC Clear Braided Tubing | 2.00" | 2.50" | 75 | 11.65 | 9.90 |

RIVULIS PRO LAYFLAT - GREEN PVC HOSE

Rivulis Irrigation's Pro-Flat brand Layflat Hose is a versatile, durable hose which meets the needs of growers everywhere. The layflat is made with premium resins which allow the product to withstand the tough conditions endured in the agricultural and the mining industries. The thick wall dimensions and the strong yarn structure help the product to hold connections and resist bursting.

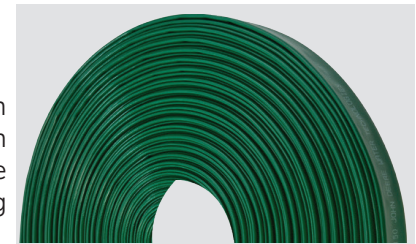

| PART # | DESCRIPTION | CLAMP SIZE | PLY | P.S.I W.P. | CUT \$/FT. | ROLL \$/FT. |
|----------|--|------------|-----|------------|------------|-------------|
| 3330-150 | 1 1/2" x 300' Green PVC Medium Pressure Layflat Hose | -150 | 2 | 90 | - | 1.20 |
| 3330-200 | 2" x 300' Green PVC Medium Pressure Layflat Hose | -20 | 2 | 80 | - | 1.20 |
| 3330-300 | 3" x 300' Green PVC Medium Pressure Layflat Hose | -30 | 2 | 70 | - | 2.05 |
| 3330-400 | 4" x 300' Green PVC Medium Pressure Layflat Hose | -40 | 2 | 70 | - | 2.65 |
| 3330-600 | 6" x 300' Green PVC Medium Pressure Layflat Hose | -60 | 2 | 50 | - | 6.20 |

PVC WATER HOSE

SUN-FLOW® SF-10 - BLUE PVC DISCHARGE HOSE

PVC Medium Pressure Blue PVC Discharge Hose. 3-Ply Polyester Yarns. Both tube and cover are extruded simultaneously to obtain maximum bonding. Applications: Mines, Construction, Irrigation, etc. Temp. Range: -5°F to 170° F. Made in U.S.A.



| PART # | DESCRIPTION | I.D. | O.D. | MAX/WP/PSI@70 | CUT \$/FT. | ROLL \$/FT. |
|-------------|--|--------|---------|---------------|------------|-------------|
| 3050-075 | 3/4" x 300' Blue PVC Low Pressure Discharge Hose | .79" | .886" | 140 | 1.00 | .85 |
| 3050-100 | 1" x 300' Blue PVC Low Pressure Discharge Hose | 1.04" | 1.144" | 110 | 1.06 | .90 |
| 3050-125 | 1 1/4" x 300' Blue PVC Low Pressure Discharge Hose | 1.30" | 1.412" | 80 | 1.06 | .90 |
| 3050-150 | 1 1/2" x 300' Blue PVC Low Pressure Discharge Hose | 1.61" | 1.728" | 80 | .76 | .65 |
| 3050-200 | 2" x 300' Blue PVC Low Pressure Discharge Hose | 2.09" | 2.208" | 80 | .82 | .70 |
| 3050-250 | 2 1/2" x 300' Blue PVC Low Pressure Discharge Hose | 2.56" | 2.678" | 65 | 1.82 | 1.55 |
| 3050-300 | 3" x 300' Blue PVC Low Pressure Discharge Hose | 3.07" | 3.196" | 80 | 2.06 | 1.75 |
| 3050-400 | 4" x 300' Blue PVC Low Pressure Discharge Hose | 4.13" | 4.264" | 70 | 2.53 | 2.15 |
| 3050-500 | 5" x 300' Blue PVC Low Pressure Discharge Hose | 5.07" | 5.212" | 40 | - | 3.90 |
| 3050-600 | 6" x 300' Blue PVC Low Pressure Discharge Hose | 6.16" | 6.310" | 60 | 4.53 | 3.85 |
| 3050-800 | 8" x 300' Blue PVC Low Pressure Discharge Hose | 8.15" | 8.324" | 35 | 9.59 | 8.15 |
| 3050-1000 | 10" x 100' or 300' Blue PVC Low Pressure Discharge Hose | 10.20" | 10.422" | 35 | 29.05 | 24.20 |
| 3050-1000HP | 10" x 100' or 300' Blue PVC Higher Pressure Discharge Hose | 10.20" | 10.452" | 80 | - | 34.60 |
| 3050-1200 | 12" x 100' or 300' Blue PVC Low Pressure Discharge Hose | 12.13" | 12.366" | 35 | 35.05 | 29.20 |
| 3050-1200HP | 12" x 100' or 300' Blue PVC Higher Pressure Discharge Hose | 12.20" | 12.468" | 60 | - | 40.70 |
| 3050-1400 | 14" x 100' or 300' Blue PVC Low Pressure Discharge Hose | 14.14" | 14.376" | 30 | 76.85 | 64.00 |
| 3050-1600 | 16" x 100' or 300' Blue PVC Low Pressure Discharge Hose | 16.14" | 16.376" | 30 | 94.50 | 78.70 |

SUN-FLOW® SF-50 RED DISCHARGE HOSE

PVC 150 PSI range Brick Red Discharge Hose. 3-Ply Polyester Yarns. Both tube and cover are extruded simultaneously to obtain maximum bonding. Applications: Mines, Construction, Irrigation, etc. Temp. Range: -5° to 170° F. Made in U.S.A.



| PART # | DESCRIPTION | I.D. | O.D. | MAX/WP/PSI@70 | CUT \$/FT. | ROLL \$/FT. |
|----------|--|-------|--------|---------------|------------|-------------|
| 6250-15 | 1 1/2" x 300' Red PVC Medium Pressure Discharge Hose | 1.61" | 1.768" | 150 | 2.29 | 1.95 |
| 6250-20 | 2" x 300' Red PVC Medium Pressure Discharge Hose | 2.09" | 2.264" | 150 | 2.88 | 2.45 |
| 6250-250 | 2 1/2" x 300' Red PVC Medium Pressure Discharge Hose | 2.56" | 2.740" | 150 | 4.00 | 3.40 |
| 6250-30 | 3" x 300' Red PVC Medium Pressure Discharge Hose | 3.07" | 3.260" | 150 | 5.00 | 4.25 |
| 6250-40 | 4" x 300' Red PVC Medium Pressure Discharge Hose | 4.13" | 4.330" | 150 | 7.24 | 6.15 |
| 6250-60 | 6" x 300' Red PVC Medium Pressure Discharge Hose | 6.18" | 6.418" | 150 | 13.18 | 11.20 |
| 6250-80 | 8" x 300' Red PVC Medium Pressure Discharge Hose | 8.19" | 8.458" | 115 | - | 22.40 |

PVC WATER HOSE

SUN-FLOW® SF-20 GREEN DISCHARGE HOSE

PVC 150-200 PSI range Green Discharge Hose. 3-Ply Polyester Yarns. Both tube and cover are extruded simultaneously to obtain maximum bonding.
 Applications: Mines, Construction, Irrigation, etc.
 Temp. Range: -5° to 170° F. Made in U.S.A.
 Recommend coupling by internally expanded method or crimping



| PART # | DESCRIPTION | CLAMP SIZE | PLY | P.S.I W.P | CUT \$/FT. | ROLL \$/FT. |
|----------|--|------------|-----|-----------|------------|-------------|
| 6350-150 | 1 1/2" x 300' Green PVC Medium Pressure Layflat Hose | -150 | 3 | 200 | - | 3.35 |
| 6350-200 | 2" x 300' Green PVC Medium Pressure Layflat Hose | -20 | 3 | 200 | - | 4.25 |
| 6350-300 | 3" x 300' Green PVC Medium Pressure Layflat Hose | -30 | 3 | 200 | - | 8.90 |
| 6350-400 | 4" x 300' Green PVC Medium Pressure Layflat Hose | -40 | 3 | 200 | - | 12.00 |
| 6350-600 | 6" x 300', Green PVC Medium Pressure Layflat Hose | -60 | 3 | 150 | - | 20.15 |
| 6350-600 | 6" x 400', 420' or 450' Green PVC Layflat Hose | -60 | 3 | 150 | - | 22.15 |
| 6350-800 | 8" x 300' Green PVC Medium Pressure Layflat Hose | -80 | 3 | 150 | - | 33.60 |

MAINLINE PREMIUM WATER DISCHARGE HOSE

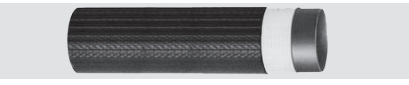

Series 2635 is a lay-flat, medium-duty water discharge and wash-down hose that combines the lightweight, compact features of PVC with the durability and abrasion resistance of conventional construction. This hose features a unique one-piece, through-the-weave construction, and attains its working pressure from a synthetic woven textile. Will not mildew or rot, and requires no drying time. Its excellent durability is derived from a high-tensile rubber compound, which completely encases the jacket. Applications include irrigation, washdown, dewatering, coal preparation and utility plants, petrochemical, oil, and gas drilling, jetting and pump discharge, storage tank cleaning, and sewer cleaning. Made in Germany.

| PART # | DESCRIPTION | CLAMP SIZE | PLY | P.S.I W.P | CUT \$/FT. | ROLL \$/FT. |
|---------|--|------------|-----|-----------|------------|-------------|
| 6300-15 | 1 1/2" x 100' or 300' Black NBR/PVC Circular Woven | -150 | 1 | 300 | 6.29 | 5.35 |
| 6300-20 | 2" x 100' or 300' Black NBR/PVC Circular Woven | -20 | 1 | 250 | 8.47 | 7.20 |
| 6300-30 | 3" x 100' or 300' Black NBR/PVC Circular Woven | -30P | 1 | 230 | 12.00 | 10.20 |
| 6300-40 | 4" x 100' or 300' Black NBR/PVC Circular Woven | -40P | 1 | 200 | 16.35 | 13.90 |
| 6300-60 | 6" x 50' or 100' Black NBR/PVC Circular Woven | -60 | 1 | 200 | 29.24 | 24.85 |
| 6300-80 | 8" x 50' or 100' Black NBR/PVC Circular Woven | -80 | 1 | 175 | 36.65 | 31.15 |

POND-FLEX® BLACK SMOOTH OD PVC HOSE



Highly flexible and durable. Glues into standard Schedule 40 PVC fittings. Simplifies pond layouts and installations. Can replace rigid PVC pipe in many applications. Suitable for above and below-ground installation.
 GENERAL APPLICATIONS: Above and below-ground circulation systems for ponds, water features and irrigation systems. 1/4" - 6", -10°F- +130°F

| PART # | DESCRIPTION | NOM. I.D. | O.D. | WEIGHT/FT | PSI @72° | ROLL \$/FT. |
|----------|------------------------------|-----------|-------|-----------|----------|-------------|
| 3870-075 | 3/4" x 100' PVC Black Hose | 3/4" | 1.02" | .21 | 350 | Call |
| 3870-100 | 1" x 100' PVC Black Hose | 1" | 1.29" | .29 | 350 | |
| 3870-150 | 1 1/2" x 100' PVC Black Hose | 1 1/2" | 1.84" | .49 | 255 | |
| 3870-200 | 2" x 100' PVC Black Hose | 2" | 2.39" | .72 | 210 | |
| 3870-300 | 3" x 100' PVC Black Hose | 3" | 3.46" | 1.29 | 150 | |
| 3870-400 | 4" x 100' PVC Black Hose | 4" | 4.56" | 2.05 | 150 | |

RUBBER WATER HOSE

6100 - BAFSCO™ SIDEWINDER RUBBER EPDM HOSE

Light, flexible, and durable with 150 PSI working pressure in all sizes. This hose is the most versatile choice for many water discharge applications. Tube and cover are flexible EPDM rubber, resistant to weathering and to many light industrial and agricultural chemicals.



| PART # | DESCRIPTION | CLAMP SIZE | PLY | P.S.I W.P | CUT \$/FT. | ROLL \$/FT. |
|---|--|------------|-----|-----------|------------|-------------|
| 6100-30 | 3" x 100' Black EPDM Rubber, Premium Wheel Line Hose | -30 | 2 | 150 | 8.48 | 7.20 |
| 6100-40 | 4" x 100' Black EPDM Rubber, Premium Wheel Line Hose | -40 | 2 | 150 | 11.66 | 9.95 |
| Medium-Duty 2-Ply Water Discharge Hose | | OD | | | | |
| 6215-15 | 1 1/2" x 100' Black SBR/EPDM Rubber Medium Duty | 1.81" | 2 | 150 | 6.30 | 5.35 |
| 6215-20 | 2" x 100' Black SBR/EPDM Rubber Cover Medium Duty | 2.31" | 2 | 150 | 6.81 | 5.80 |
| 6215-25 | 2 1/2" Black SBR/EPDM Rubber Cover Medium Duty | 2.81" | 2 | 150 | 9.12 | 7.75 |
| 6215-30 | 3" x 100' Black SBR/EPDM Rubber Cover Medium Duty | 3.31" | 2 | 150 | 9.35 | 7.95 |
| 6215-40 | 4" x 100 Black SBR/EPDM Rubber Cover Medium Duty | 4.31" | 2 | 150 | 12.82 | 10.90 |
| 6215-60 | 6" x 100' Black SBR/EPDM Rubber Cover Medium Duty | 6.34" | 2 | 100 | 21.53 | 18.30 |
| 6215-80 | 8" x 100' Black SBR/EPDM Rubber Cover Medium Duty | 8.35" | 2 | 100 | 41.13 | 34.95 |
| 6215-100 | 10" x 100' Black SBR/EPDM Rubber Cover Medium Duty | 10.42" | 2 | 80 | 49.53 | 41.10 |

6400 - 4 PLY - HEAVY DUTY WATER DISCRHARGE HOSE

Heavy-Duty 4-Ply Water Discharge Hose. Soft-wall design gives similar performance to a lay-flat hose, but with increased abrasion resistance and tensile strength. FLO-HD is made of a premium-quality SBR/EPDM blend for maximum weather resistance and life in abusive service.



| PART # | DESCRIPTION | OD | PLY | P.S.I W.P | CUT \$/FT. | ROLL \$/FT. |
|----------|--|--------|-----|-----------|------------|-------------|
| 6400-15 | 1 1/2" x 100' Black SBR/EPDM Rubber Heavy Duty | 1.90" | 4 | 250 | 8.41 | 7.15 |
| 6400-20 | 2" x 100' Black SBR/EPDM Rubber Heavy Duty | 2.40" | 4 | 250 | 9.82 | 8.35 |
| 6400-25 | 2 1/2" x 100' Black SBR/EPDM Rubber Heavy Duty | 2.90" | 4 | 250 | 11.88 | 10.10 |
| 6400-30 | 3" x 100' Black SBR/EPDM Rubber Heavy Duty | 3.40" | 4 | 250 | 12.89 | 10.95 |
| 6400-40 | 4" x 100' Black SBR/EPDM Rubber Heavy Duty | 4.42" | 4 | 200 | 17.76 | 15.10 |
| 6400-45 | 4 1/2" x 100' Black SBR/EPDM Rubber Heavy Duty | 4.92" | 4 | 200 | 27.47 | 23.35 |
| 6400-50 | 5" X 100" Black SBR/EPDM Rubber Heavy Duty | 5.44" | 4 | 200 | 32.77 | 27.85 |
| 6400-60 | 6" x 100' Black SBR/EPDM Rubber Heavy Duty | 6.45" | 4 | 200 | 29.35 | 24.95 |
| 6400-80 | 8" x 100' Black SBR/EPDM Rubber Heavy Duty | 8.47" | 4 | 200 | 50.41 | 42.85 |
| 6400-100 | 10" x 100' Black SBR/EPDM Rubber Heavy Duty | 10.53" | 4 | 150 | 70.18 | 59.65 |
| 6400-120 | 12" x 50' Black SBR/EPDM Rubber Heavy Duty | 12.53" | 4 | 150 | 93.12 | 79.15 |

RUBBER WATER HOSE

MULTI PURPOSE HOSE – BLACK (200 PSI)

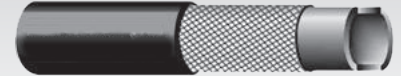

An economical and versatile general purpose hose. Excellent for air and water service, as well as many agricultural chemicals including Lasso® herbicide. EPDM tube and cover resists heat, sunlight, ozone and weathering. This hose exceeds ARPM Class C medium oil resistance requirements. Suitable for applications such as oil mist lubricating air lines, but not suitable for the transfer of petroleum products

| PART # | DESCRIPTION | CLAMP SIZE | P.S.I W.P. | O.D. | CUT \$/FT. | ROLL \$/FT. |
|--------|---|------------|------------|------|------------|-------------|
| MPH25 | 1/4" x 750' Black EPDM Multi-Purpose Hose | | 250 | .53 | 1.35 | 1.15 |
| MPH38 | 3/8" x 750' Black EPDM Multi-Purpose Hose | | 250 | .70 | 1.76 | 1.50 |
| MPH50 | 1/2" x 700' Black EPDM Multi-Purpose Hose | | 200 | .81 | 2.06 | 1.75 |
| MPH58 | 5/8" x 700' Black EPDM Multi-Purpose Hose | | 200 | .97 | 2.71 | 2.30 |
| MPH75 | 3/4" x 500' Black EPDM Multi-Purpose Hose | | 200 | 1.12 | 3.29 | 2.80 |
| MPH100 | 1" x 400' Black EPDM Multi-Purpose Hose | | 200 | 1.44 | 5.20 | 4.40 |

GENERAL SERVICE HOSE – RED (250 PSI)



A tough, heavy-duty, abrasion and ozone-resistant general service hose. Designed for the transfer of air, mild chemicals and water across multiple applications. The ability to order this product in continuous lengths provides efficiently in inventory controls as well as ease of handling at job sites. Available in 1/4" thru 2"

| PART # | DESCRIPTION | CLAMP SIZE | P.S.I W.P. | O.D. | CUT \$/FT. | ROLL \$/FT. |
|--------|--|------------|------------|------|------------|-------------|
| GSH050 | 1/2" x 200' or 600' Red SBR/EPDM Cover, Black EPDM Tube | -10 | 250 | .83 | 1.53 | 1.30 |
| GSH075 | 3/4" x 600', 200' or 50' Red SBR/EPDM Cover, Black EPDM Tube | -12 | 250 | 1.14 | 2.65 | 2.25 |
| GSH100 | 1" x 400' or 50' Red SBR/EPDM Cover, Black EPDM Tube | -16 | 250 | 1.42 | 3.65 | 3.10 |
| GSH125 | 1 1/4" x 300' Red SBR/EPDM Cover, Black EPDM Tube | -24 | 250 | 1.73 | 6.12 | 5.20 |
| GSH150 | 1 1/2" x 250' Red SBR/EPDM Cover, Black EPDM Tube | -28 | 250 | 2.12 | 9.65 | 8.20 |
| GSH200 | 2" x 200' Red SBR/EPDM Cover, Black EPDM Tube | -36 | 250 | 2.59 | 12.05 | 10.25 |

6200 - RUBBER SUCTION HOSE W/WIRE HELIX

This water suction hose is tough, with flexible SBR/EPDM rubber construction that resists abrasion, weathering, the effects of agricultural herbicides and other mild chemicals. Incorporates a steel dual wire helix in the hose wall for full suction capabilities as well as high tensile tire cord fabric for discharge pressure.



| PART # | DESCRIPTION | O.D. | P.S.I W.P. | LENGTH | CUT \$/FT. | ROLL \$/FT. |
|--|--|----------|------------|-----------|------------|-------------|
| 6200-10 | 1" SBR/EPDM Rubber Cover Wire Reinforced | 1 19/64" | 150 | 100' | 7.05 | 6.00 |
| 6200-125 | 1 1/4" SBR/EPDM Rubber Cover Wire Reinforced | 1 5/8" | 150 | 100' | 8.06 | 6.85 |
| 6200-15 | 1 1/2" SBR/EPDM Rubber Cover Wire Reinforced | 1 7/8" | 150 | 100' | 8.24 | 7.00 |
| 6200-20 | 2" x SBR/EPDM Rubber Cover Wire Reinforced | 2 7/16" | 150 | 100'/200' | 9.36 | 7.95 |
| 6200-25 | 2 1/2" SBR/EPDM Rubber Cover Wire Reinforced | 2 7/8" | 150 | 100' | 12.82 | 10.90 |
| 6200-30 | 3" x SBR/EPDM Rubber Cover Wire Reinforced | 3 29/64" | 150 | 100'/200' | 14.00 | 11.90 |
| 6200-40 | 4" x SBR/EPDM Rubber Cover Wire Reinforced | 4 1/2" | 150 | 100'/200' | 21.05 | 17.90 |
| 6200-60 | 6" x SBR/EPDM Rubber Cover Wire Reinforced | 6 5/8" | 150 | 20'/100' | 40.24 | 34.20 |
| 6200-80 | 8" x SBR/EPDM Rubber Cover Wire Reinforced | 8 5/8" | 150 | 20'/100' | 73.05 | 62.10 |
| 6280 - CORRUGATED RUBBER SUCTION HOSE | | | | | | |
| 6280-50 | 5" x 100' EPDM Rubber Cover Wire Reinforced | 5 41/64" | 150 | 100' | 36.00 | 30.60 |
| 6280-60 | 6" x 100' EPDM Rubber Cover Wire Reinforced | 6 11/16" | 150 | 20'/100' | 40.24 | 34.20 |
| 6280-80 | 8" x 100' EPDM Rubber Cover Wire Reinforced | 8 3/4" | 150 | 20'/100' | 73.05 | 62.10 |
| 6280-100 | 10" x 100' EPDM Rubber Cover Wire Reinforced | 10 3/4" | 50 | 20'/25' | 127.30 | 108.20 |
| 6280-120 | 12" x 100' EPDM Rubber Cover Wire Reinforced | 12 7/8" | 50 | 20'/25' | 161.30 | 134.10 |

ALUMINUM CAMLOCKS

A



MALE ADAPTER X FEMALE NPT

| PART # | SIZE | LIST |
|--------|--------|--------|
| 37AA | 3/4" | 3.75 |
| 310AA | 1" | 4.45 |
| 312AA | 1 1/4" | 5.25 |
| 315AA | 1 1/2" | 4.65 |
| 320AA | 2" | 5.65 |
| 325AA | 2 1/2" | 9.75 |
| 330AA | 3" | 11.10 |
| 340AA | 4" | 17.25 |
| 360AA | 6" | 38.60 |
| 380AA | 8"* | 141.05 |

B



FEMALE COUPLER X MALE NPT

| PART # | SIZE | LIST |
|--------|--------|--------|
| 37BA | 3/4" | 6.85 |
| 310BA | 1" | 8.20 |
| 312BA | 1 1/4" | 10.65 |
| 315BA | 1 1/2" | 11.30 |
| 320BA | 2" | 13.10 |
| 325BA | 2 1/2" | 18.90 |
| 330BA | 3" | 21.35 |
| 340BA | 4" | 29.30 |
| 360BA | 6" | 75.15 |
| 380BA | 8"* | 278.15 |

C



FEMALE COUPLER X HOSE SHANK

| PART # | SIZE | LIST |
|--------|--------|--------|
| 37CA | 3/4" | 7.15 |
| 310CA | 1" | 8.25 |
| 312CA | 1 1/4" | 10.95 |
| 315CA | 1 1/2" | 11.75 |
| 320CA | 2" | 13.90 |
| 325CA | 2 1/2" | 19.75 |
| 330CA | 3" | 24.70 |
| 340CA | 4" | 33.15 |
| 360CA | 6" | 88.10 |
| 380CA | 8"* | 280.85 |

D



FEMALE COUPLER X FEMALE NPT

| PART # | SIZE | LIST |
|--------|--------|--------|
| 37DA | 3/4" | 7.45 |
| 310DA | 1" | 8.45 |
| 312DA | 1 1/4" | 11.50 |
| 315DA | 1 1/2" | 11.55 |
| 320DA | 2" | 13.80 |
| 325DA | 2 1/2" | 20.10 |
| 330DA | 3" | 22.95 |
| 340DA | 4" | 31.70 |
| 360DA | 6" | 79.35 |
| 380DA | 8"* | 321.85 |

E



MALE ADAPTER X HOSE SHANK

| PART # | SIZE | LIST |
|--------|--------|--------|
| 37EA | 3/4" | 3.60 |
| 310EA | 1" | 4.55 |
| 312EA | 1 1/4" | 5.55 |
| 315EA | 1 1/2" | 5.65 |
| 320EA | 2" | 8.25 |
| 325EA | 2 1/2" | 12.45 |
| 330EA | 3" | 14.85 |
| 340EA | 4" | 25.20 |
| 360EA | 6" | 58.95 |
| 380EA | 8"* | 177.20 |

F



MALE ADAPTER X MALE NPT

| PART # | SIZE | LIST |
|--------|--------|--------|
| 37FA | 3/4" | 4.30 |
| 310FA | 1" | 4.90 |
| 312FA | 1 1/4" | 6.50 |
| 315FA | 1 1/2" | 5.95 |
| 320FA | 2" | 7.85 |
| 325FA | 2 1/2" | 13.65 |
| 330FA | 3" | 16.10 |
| 340FA | 4" | 25.85 |
| 360FA | 6" | 57.10 |
| 380FA | 8"* | 200.55 |

DC



DUST CAP ALUMINUM CAMLOCK

| PART # | SIZE | LIST |
|--------|--------|-------|
| 37DCA | 3/4" | 6.60 |
| 310DCA | 1" | 7.75 |
| 312DCA | 1 1/4" | 9.70 |
| 315DCA | 1 1/2" | 10.60 |
| 320DCA | 2" | 12.20 |
| 325DCA | 2 1/2" | 16.10 |
| 330DCA | 3" | 19.80 |
| 340DCA | 4" | 26.80 |
| 360DCA | 6" | 61.35 |

DP



DUST PLUG ALUMINUM CAMLOCK

| PART # | SIZE | LIST |
|--------|--------|-------|
| 37DPA | 3/4" | 2.80 |
| 310DPA | 1" | 3.05 |
| 312DPA | 1 1/4" | 4.10 |
| 315DPA | 1 1/2" | 4.00 |
| 320DPA | 2" | 5.35 |
| 325DPA | 2 1/2" | 8.35 |
| 330DPA | 3" | 8.95 |
| 340DPA | 4" | 15.05 |
| 360DPA | 6" | 32.65 |



5" ALUMINUM CAMLOCKS

| PART # | SIZE | LIST |
|--------|------|-------|
| 350AA | 5" | 28.95 |
| 350BA | 5" | 51.20 |
| 350CA | 5" | 61.80 |
| 350DA | 5" | 51.10 |
| 350EA | 5" | 51.60 |
| 350FA | 5" | 42.95 |
| 350DCA | 5" | 44.60 |
| 350DPA | 5" | 27.00 |

* INTERCHANGES WITH NAE

ALUMINUM CAMLOCKS



DOUBLE "A"

| PART # | SIZE | LIST |
|----------|-------------|--------|
| 310AAA | 1" | 6.80 |
| 312AAA | 1 1/4" | 18.35 |
| 315AAA | 1 1/2" | 19.30 |
| 31520AAA | 1 1/2" x 2" | 26.25 |
| 31520AAA | 2" | 22.25 |
| 32030AAA | 2" x 3" | 30.80 |
| 330AAA | 3" | 31.20 |
| 33040AAA | 3" x 4" | 55.60 |
| 3340AAA | 4" | 47.85 |
| 34060AAA | 4" x 6" | 78.60 |
| 360AAA | 6" | 113.90 |



REDUCING "DA"

| PART # | SIZE | LIST |
|----------|-------------|--------|
| 31510DAA | 1 1/2" x 1" | 30.85 |
| 31520DAA | 1 1/2" x 2" | 34.80 |
| 32015DAA | 2" x 1 1/2" | 35.60 |
| 32030DAA | 2" x 3" | 45.45 |
| 32040DAA | 2" x 4" | 58.10 |
| 33015DAA | 3" X 1 1/2" | 55.35 |
| 33020DAA | 3" X 2" | 51.65 |
| 33040DAA | 3" X 4" | 65.75 |
| 34020DAA | 4" x 2" | 68.50 |
| 34030DAA | 4" x 3" | 64.00 |
| 34060DAA | 4" X 6" | 119.80 |
| 36040DAA | 6" X 4" | 136.60 |



DOUBLE "D"

| PART # | SIZE | LIST |
|--------|--------|-------|
| 315DDA | 1 1/2" | 34.90 |
| 320DDA | 2" | 40.80 |
| 330DDA | 3" | 63.00 |
| 340DDA | 4" | 78.45 |



ALUMINUM PLATE FILTER

| PART # | SIZE | LIST |
|--------|--------------------|-------|
| 315PFA | 1 1/2" x 1/4" Hole | 25.65 |
| 320PFA | 2" x 1/4" Hole | 29.90 |
| 330PFA | 3" x 1/4" Hole | 31.50 |
| 340PFA | 4" x 1/4" Hole | 42.55 |



STEP SIZE "A"

| PART # | ADAPTER/FPT | LIST |
|---------|-------------|-------|
| 32030AA | 2" x 3" | 30.05 |
| 33020AA | 3" x 2" | 30.05 |
| 33040AA | 3" x 4" | 47.90 |
| 34030AA | 4" x 3" | 49.00 |
| 34060AA | 4" x 6" | 78.60 |



STEP SIZE "B"

| PART # | COUPLER/MPT | LIST |
|---------|-------------|-------|
| 31510BA | 1 1/2" x 1" | 25.65 |
| 32015BA | 2" x 1 1/2" | 28.10 |
| 33020BA | 3" x 2" | 47.30 |
| 33040BA | 3" x 4" | 58.90 |
| 34030BA | 4" x 3" | 61.35 |



STEP SIZE "C"

| PART # | COUPLER/BARB | LIST |
|---------|--------------|-------|
| 33020CA | 3" x 2" | 50.20 |
| 33040CA | 3" x 4" | 61.75 |
| 34030CA | 4" x 3" | 66.65 |



STEP SIZE "D"

| PART # | COUPLER/FPT | LIST |
|---------|-------------|-------|
| 31510DA | 1 1/2" x 1" | 28.35 |
| 32015DA | 2" x 1 1/2" | 29.45 |
| 33020DA | 3" x 2" | 42.85 |
| 34030DA | 4" x 3" | 62.25 |



STEP SIZE "F"

| PART # | ADAPTER/MPT | LIST |
|---------|-------------|-------|
| 33015FA | 3" x 1 1/2" | 37.30 |
| 33020FA | 3" x 2" | 31.95 |
| 33040FA | 3" x 4" | 51.75 |



STEP SIZE "C"

| PART # | COUPLER/BARB | LIST |
|---------|--------------|-------|
| 33020CA | 3" x 2" | 50.20 |
| 33040CA | 3" x 4" | 61.75 |
| 34030CA | 4" x 3" | 66.65 |

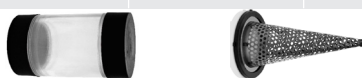

FUNNEL STRAINER

| PART # | SIZE | LIST |
|--------|------|-------|
| FS25 | 2" | 13.85 |
| FS35 | 3" | 14.70 |
| FS45 | 4" | 17.50 |



SIGHT GLASS ASSEMBLY

| PART # | SIZE | LIST |
|----------|------|--------|
| SSA200AL | 2" | 74.00 |
| SSA300AL | 3" | 124.45 |
| SSA400AL | 4" | 232.20 |

POLYCARBONATE SIGHT GLASS

| PART # | SIZE | LIST |
|--------|------|-------|
| TSG200 | 2" | 24.40 |
| TSG300 | 3" | 50.95 |
| TSG400 | 4" | 69.20 |

POLYPROPYLENE CAMLOCKS

A



B



C



MALE ADAPTER X FEMALE NPT

| PART # | SIZE | LIST |
|--------|--------|-------|
| 37AP | 3/4" | 1.25 |
| 310AP | 1" | 1.35 |
| 312AP | 1 1/4" | 2.25 |
| 315AP | 1 1/2" | 2.35 |
| 320AP | 2" | 3.80 |
| 330AP | 3" | 5.10 |
| 340AP | 4" | 12.20 |

FEMALE COUPLER X MALE NPT

| PART # | SIZE | LIST |
|--------|--------|-------|
| 37BP | 3/4" | 5.30 |
| 310BP | 1" | 6.75 |
| 312BP | 1 1/4" | 11.35 |
| 315BP | 1 1/2" | 10.30 |
| 320BP | 2" | 12.25 |
| 330BP | 3" | 19.05 |
| 340BP | 4" | 40.00 |

FEMALE COUPLER X HOSE SHANK

| PART # | SIZE | LIST |
|--------|--------|-------|
| 37CP | 3/4" | 5.30 |
| 310CP | 1" | 6.90 |
| 312CP | 1 1/4" | 11.75 |
| 315CP | 1 1/2" | 10.70 |
| 320CP | 2" | 13.45 |
| 330CP | 3" | 20.75 |
| 340CP | 4" | 44.30 |

D



E



F



FEMALE COUPLER X FEMALE NPT

| PART # | SIZE | LIST |
|--------|--------|-------|
| 37DP | 3/4" | 5.30 |
| 310DP | 1" | 6.90 |
| 312DP | 1 1/4" | 11.35 |
| 315DP | 1 1/2" | 10.75 |
| 320DP | 2" | 12.80 |
| 330DP | 3" | 19.80 |
| 340DP | 4" | 41.40 |

MALE ADAPTER X HOSE SHANK

| PART # | SIZE | LIST |
|--------|--------|-------|
| 37EP | 3/4" | 1.25 |
| 310EP | 1" | 1.60 |
| 312EP | 1 1/4" | 2.55 |
| 315EP | 1 1/2" | 2.40 |
| 320EP | 2" | 4.50 |
| 330EP | 3" | 6.85 |
| 340EP | 4" | 16.95 |

MALE ADAPTER X MALE NPT

| PART # | SIZE | LIST |
|--------|--------|-------|
| 37FP | 3/4" | 1.20 |
| 310FP | 1" | 1.60 |
| 312FP | 1 1/4" | 2.30 |
| 315FP | 1 1/2" | 2.30 |
| 320FP | 2" | 5.40 |
| 330FP | 3" | 5.90 |
| 340FP | 4" | 15.55 |

DC



DP



CG



DUST CAP POLY CAMLOCK

| PART # | SIZE | LIST |
|--------|--------|-------|
| 37DCP | 3/4" | 4.60 |
| 310DCP | 1" | 6.60 |
| 312DCP | 1 1/4" | 10.20 |
| 315DCP | 1 1/2" | 10.20 |
| 320DCP | 2" | 12.50 |
| 330DCP | 3" | 18.35 |
| 340DCP | 4" | 36.70 |

DUST PLUG POLY CAMLOCK

| PART # | SIZE | LIST |
|--------|--------|------|
| 37DPP | 3/4" | 1.05 |
| 310DPP | 1" | 1.20 |
| 312DPP | 1 1/4" | 2.40 |
| 315DPP | 1 1/2" | 1.90 |
| 320DPP | 2" | 2.85 |
| 330DPP | 3" | 4.60 |
| 340DPP | 4" | 9.75 |

CAMLOCK GASKETS - BUNA

| PART # | SIZE | LIST |
|--------|--------|------|
| 37CG | 3/4" | .50 |
| 310CG | 1" | .50 |
| 312CG | 1 1/4" | .80 |
| 315CG | 1 1/2" | .80 |
| 320CG | 2" | .90 |
| 330CG | 3" | 1.55 |
| 340CG | 4" | 2.00 |
| 360CG | 6" | 3.50 |

NYLON CAMLOCKS

A



B



C



MALE ADAPTER X FEMALE NPT

| PART # | SIZE | LIST |
|--------|--------|-------|
| 37AN | 3/4" | 4.65 |
| 310AN | 1" | 5.10 |
| 312AN | 1 1/4" | 8.20 |
| 315AN | 1 1/2" | 8.00 |
| 320AN | 2" | 8.70 |
| 330AN | 3" | 19.15 |
| 340AN | 4" | 34.60 |

FEMALE COUPLER X MALE NPT

| PART # | SIZE | LIST |
|--------|--------|-------|
| 37BN | 3/4" | 11.55 |
| 310BN | 1" | 13.80 |
| 312BN | 1 1/4" | 18.35 |
| 315BN | 1 1/2" | 18.35 |
| 320BN | 2" | 20.70 |
| 330BN | 3" | 35.25 |
| 340BN | 4" | 49.05 |

FEMALE COUPLER X HOSE SHANK

| PART # | SIZE | LIST |
|--------|--------|-------|
| 37CN | 3/4" | 11.55 |
| 310CN | 1" | 13.20 |
| 312CN | 1 1/4" | 19.05 |
| 315CN | 1 1/2" | 18.35 |
| 320CN | 2" | 20.85 |
| 330CN | 3" | 32.70 |
| 340CN | 4" | 47.60 |

D



E

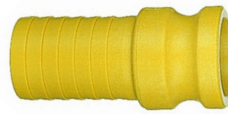

F



FEMALE COUPLER X FEMALE NPT

| PART # | SIZE | LIST |
|--------|--------|-------|
| 37DN | 3/4" | 10.75 |
| 310DN | 1" | 13.05 |
| 312DN | 1 1/4" | 19.15 |
| 315DN | 1 1/2" | 18.70 |
| 320DN | 2" | 20.85 |
| 330DN | 3" | 36.00 |
| 340DN | 4" | 52.05 |

MALE ADAPTER X HOSE SHANK

| PART # | SIZE | LIST |
|--------|--------|-------|
| 37EN | 3/4" | 6.10 |
| 310EN | 1" | 7.05 |
| 312EN | 1 1/4" | 8.60 |
| 315EN | 1 1/2" | 8.25 |
| 320EN | 2" | 9.55 |
| 330EN | 3" | 18.25 |
| 340EN | 4" | 33.70 |

MALE ADAPTER X MALE NPT

| PART # | SIZE | LIST |
|--------|--------|-------|
| 37FN | 3/4" | 6.10 |
| 310FN | 1" | 6.60 |
| 312FN | 1 1/4" | 9.05 |
| 315FN | 1 1/2" | 9.60 |
| 320FN | 2" | 9.20 |
| 330FN | 3" | 23.00 |
| 340FN | 4" | 36.80 |



DUST CAP NYLON CAMLOCK

| PART # | SIZE | LIST |
|--------|--------|-------|
| 37DCN | 3/4" | 10.75 |
| 310DCN | 1" | 12.25 |
| 315DCN | 1 1/2" | 18.10 |
| 320DCN | 2" | 20.40 |
| 330DCN | 3" | 31.40 |
| 340DCN | 4" | 42.15 |

DUST PLUG NYLON CAMLOCK

| PART # | SIZE | LIST |
|--------|--------|-------|
| 37DPN | 3/4" | 4.90 |
| 310DPN | 1" | 5.50 |
| 315DPN | 1 1/2" | 6.60 |
| 320DPN | 2" | 8.00 |
| 330DPN | 3" | 19.90 |
| 340DPN | 4" | 25.25 |

NYLON HOSE NIPPLE

| PART # | SIZE | LIST |
|---------|--------|-------|
| 346-075 | 3/4" | 2.75 |
| 346-100 | 1" | 3.10 |
| 346-125 | 1 1/4" | 3.70 |
| 346-150 | 1 1/2" | 4.05 |
| 346-200 | 2" | 6.10 |
| 346-300 | 3" | 13.80 |
| 346-400 | 4" | 19.90 |

TERREMAX® POLYPROPYLENE CAMLOCKS



MALE ADAPTER X FEMALE NPT

| PART # | MALE ADAPTER | FEMALE NPT | LIST |
|---------|--------------|------------|-------|
| 050A | 3/4" | 1/2" FPT | 4.55 |
| 075A | 3/4" | 3/4" FPT | 4.55 |
| 100A | 1" | 1" FPT | 4.55 |
| 125A | 1" | 1 1/4" FPT | 4.55 |
| 150125A | 1 1/2" | 1 1/4" FPT | 5.15 |
| 150A | 1 1/2" | 1 1/4" FPT | 5.15 |
| 200A | 2" | 2" FPT | 6.10 |
| 300A | 3" | 3" FPT | 14.70 |
| 400A | 4" | 4" FPT | 22.45 |

FEMALE COUPLER X MALE NPT

| PART # | FEMALE COUPLER | MALE NPT | LIST |
|---------|----------------|------------|-------|
| 050B | 3/4" | 1/2" MPT | 10.40 |
| 075B | 3/4" | 3/4" MPT | 10.40 |
| 100B | 1" | 1" MPT | 11.95 |
| 125B | 1" | 1 1/4" MPT | 11.95 |
| 150125B | 1 1/2" | 1 1/4" MPT | 14.00 |
| 150B | 1 1/2" | 1 1/2" MPT | 14.00 |
| 200B | 2" | 2" MPT | 17.05 |
| 300B | 3" | 3" MPT | 28.65 |
| 400B | 4" | 4" MPT | 56.80 |

FEMALE COUPLER X HOSE BARB

| PART # | FEMALE COUPLER | HOSE BARB | LIST |
|---------|----------------|-------------|-------|
| 050C | 3/4" | 1/2" BARB | 10.40 |
| 075C | 3/4" | 3/4" BARB | 10.40 |
| 100C | 1" | 1" BARB | 11.95 |
| 125C | 1" | 1 1/4" BARB | 11.95 |
| 150125C | 1 1/2" | 1 1/4" BARB | 14.00 |
| 150C | 1 1/2" | 1 1/2" BARB | 14.00 |
| 200C | 2" | 2" BARB | 17.05 |
| 300C | 3" | 3" BARB | 28.65 |
| 400C | 4" | 4" BARB | 56.80 |



FEMALE COUPLER X FEMALE NPT

| PART # | FEMALE COUPLER | FEMALE NPT | LIST |
|---------|----------------|------------|-------|
| 050D | 3/4" | 1/2" FPT | 10.40 |
| 075D | 3/4" | 3/4" FPT | 10.40 |
| 100D | 1" | 1" FPT | 11.95 |
| 125D | 1" | 1 1/4" FPT | 11.95 |
| 150125D | 1 1/2" | 1 1/4" FPT | 14.00 |
| 150D | 1 1/2" | 1 1/4" FPT | 14.00 |
| 200D | 2" | 2" FPT | 17.05 |
| 300D | 3" | 3" FPT | 28.65 |
| 400D | 4" | 4" FPT | 56.80 |

MALE ADAPTER X HOSE BARB

| PART # | MALE ADAPTER | HOSE BARB | LIST |
|---------|--------------|-------------|-------|
| 050E | 3/4" | 1/2" BARB | 4.90 |
| 075E | 3/4" | 3/4" BARB | 4.90 |
| 100E | 1" | 1" BARB | 5.50 |
| 125E | 1" | 1 1/4" BARB | 5.50 |
| 150125E | 1 1/2" | 1 1/4" BARB | 5.50 |
| 150E | 1 1/2" | 1 1/2" BARB | 5.50 |
| 200E | 2" | 2" BARB | 7.20 |
| 300E | 3" | 3" BARB | 18.85 |
| 400E | 4" | 4" BARB | 22.45 |

MALE ADAPTER X MALE NPT

| PART # | MALE ADAPTER | MALE NPT | LIST |
|---------|--------------|------------|-------|
| 050F | 3/4" | 1/2" MPT | 4.90 |
| 075F | 3/4" | 3/4" MPT | 4.90 |
| 100F | 1" | 1" MPT | 5.50 |
| 125F | 1" | 1 1/4" MPT | 5.50 |
| 150125F | 1 1/2" | 1 1/4" MPT | 5.50 |
| 150F | 1 1/2" | 1 1/2" MPT | 5.50 |
| 200F | 2" | 2" MPT | 7.20 |
| 300F | 3" | 3" MPT | 18.85 |
| 400F | 4" | 4" MPT | 22.45 |



CAP

CAP FOR MALE ADAPTER

| PART # | SIZE | LIST |
|-----------|--------|-------|
| 050075CAP | 3/4" | 10.40 |
| 100125CAP | 1" | 11.50 |
| 150CAP | 1 1/2" | 14.00 |
| 200CAP | 2" | 17.10 |
| 300CAP | 3" | 28.65 |
| 400CAP | 4" | 41.40 |



PLUG

PLUG FOR FEMALE COUPLER

| PART # | SIZE | LIST |
|----------|--------|-------|
| 050075PL | 3/4" | 4.90 |
| 100125PL | 1" | 4.90 |
| 150PL | 1 1/2" | 5.30 |
| 200PL | 2" | 7.15 |
| 300PL | 3" | 14.95 |
| 400PL | 4" | 17.65 |



- Glass Filled Polypropylene
- 1/2" thru 2" Maximum Operating Pressure 125 psi @ 70°F
- 3" and 4" Maximum Operating Pressure 125 psi @ 70°F
- EPDM Gaskets
- 1/2" series couplings interchange with 3/4" size couplings. Coupling ends are 3/4" size
- 1 1/4" series couplings interchange with 1" size couplings. Coupling ends are 1" size
- 4" Camlocks have 3 arms

TERREMAX® POLYPROPYLENE CAMLOCKS



SWEEP 90°

| PART # | BARB/COUPLER | LIST |
|-----------|--------------|-------|
| 200CSWP90 | 2" | 25.60 |



SWEEP 90°

| PART # | ADAPTER/MPT | LIST |
|-----------|-------------|-------|
| 200FSWP90 | 2" | 12.90 |
| 300FSWP90 | 3" | 35.15 |



SPOOL ADAPTER

| PART # | ADAPTER/ADAPTER | LIST |
|--------|-----------------|-------|
| 200FF | 2" | 14.70 |



2" X 3" ADAPTER

| PART # | FEMALE COUPLER | MALE ADAPTER | LIST |
|----------|----------------|--------------|-------|
| 300B200A | 3" | 2" | 28.65 |



2" X 3" ADAPTER

| PART # | FEMALE NPT | MALE ADAPTER | LIST |
|---------|------------|--------------|-------|
| 300200A | 3" | 2" | 13.25 |



2" X 3" ADAPTER

| PART # | FEMALE COUPLER | FEMALE NPT | LIST |
|---------|----------------|------------|-------|
| 300200D | 3" | 2" | 28.65 |



F SERIES

| PART # | MALE ADAPTER | MALE NPT | LIST |
|--------|--------------|----------|-------|
| 200F45 | 2" | 2" | 16.40 |



2 holes on handle for mounting

PLUG WITH LARGE HANDLE

| PART # | ADAPTER | LIST |
|--------|---------|-------|
| 200PLH | 2" | 14.85 |
| 300PLH | 3" | 22.65 |



PRESSURE SEAL HD CLAMPS

| PART # | RANGE | HOSE | LIST |
|--------|---------------|--------|------|
| PC12 | .81" - 1.04" | 1/2" | 3.55 |
| PC14 | .88" - 1.17" | 3/4" | 3.60 |
| PC16 | 1.13" - 1.45" | 1" | 5.10 |
| PC20 | 1.13" - 1.56" | 1" | 5.20 |
| PC24 | 1.50" - 1.82" | 1 1/4" | 5.50 |
| PC28 | 1.55" - 2.25" | | 5.50 |
| PC238 | 1.62" - 2.12" | 1 1/2" | 7.75 |
| PC262 | 1.88" - 2.37" | | 7.85 |
| PC275 | 2.00" - 2.50" | 2" | 8.10 |
| PC288 | 2.12" - 2.62" | 2" | 8.20 |
| PC300 | 2.25" - 2.75" | | 8.30 |
| PC325 | 2.50" - 3.00" | | 8.30 |
| PC350 | 2.75" - 3.25" | | 8.35 |
| PC375 | 2.88" - 3.50" | | 8.50 |
| PC400 | 3.12" - 3.75" | 3" | 8.75 |
| PC425 | 3.31" - 4.00" | | 8.90 |
| PC450 | 3.44" - 4.25" | | 9.60 |
| PC512 | 4.06" - 4.87" | 4" | 9.80 |



BULK HEAD FITTINGS

BULK HEAD FITTINGS EPDM GASKET

| PART # | FEMALE NPT | HOLE SIZE | LIST |
|--------|------------|-----------|-------|
| TF050 | 1/2" | 1 5/8" | 5.75 |
| TF075 | 3/4" | 1 5/8" | 5.50 |
| TF100 | 1" | 2 1/4" | 7.30 |
| TF150 | 1 1/2" | 3" | 12.75 |
| TF200 | 2" | 3" | 12.75 |
| TF300 | 3" | 4 1/2" | 39.75 |
| TF400 | 4" | 5 3/4" | 98.65 |

BULK HEAD FITTINGS VITON GASKET

| PART # | FEMALE NPT | HOLE SIZE | LIST |
|--------|------------|-----------|-------|
| TF050V | 1/2" | 1 5/8" | 18.75 |
| TF075V | 3/4" | 1 5/8" | 17.90 |
| TF100V | 1" | 2 1/4" | 25.05 |
| TF150V | 1 1/2" | 3" | 30.80 |
| TF200V | 2" | 3" | 34.80 |
| TF220V | 2" | 3 1/4" | 63.55 |
| TF300V | 3" | 4 1/2" | 84.65 |

Spring Compression of liner creates 360° pressure on hose

TERREMAX SCH 80 POLYPROPYLENE



STRAIGHT ADAPTER

| PART # | MALE NPT | BARB | LIST |
|----------|----------|--------|-------|
| HB025 | 1/4" | 1/4" | 1.75 |
| HB025038 | 1/4" | 3/8" | 1.75 |
| HB025050 | 1/4" | 1/2" | 2.10 |
| HB038 | 3/8" | 3/8" | 1.90 |
| HB038025 | 3/8" | 1/4" | 1.55 |
| HB038050 | 3/8" | 1/2" | 1.90 |
| HB050038 | 1/2" | 3/8" | 1.90 |
| HB050 | 1/2" | 1/2" | 1.75 |
| HB050075 | 1/2" | 3/4" | 2.10 |
| HB075038 | 3/4" | 3/8" | 2.10 |
| HB075050 | 3/4" | 1/2" | 1.95 |
| HB075 | 3/4" | 3/4" | 1.95 |
| HB075100 | 3/4" | 1" | 2.40 |
| HB100075 | 1" | 3/4" | 2.40 |
| HB100 | 1" | 1" | 2.40 |
| HB100125 | 1" | 1 1/4" | 2.95 |
| HB125100 | 1 1/4" | 1" | 2.95 |
| HB125 | 1 1/4" | 1 1/4" | 2.95 |
| HB150100 | 1 1/2" | 1" | 4.80 |
| HB150125 | 1 1/2" | 1 1/4" | 4.00 |
| HB150 | 1 1/2" | 1 1/2" | 3.70 |
| HB150200 | 1 1/2" | 2" | 6.90 |
| HB200150 | 2" | 1 1/2" | 6.90 |
| HB200 | 2" | 2" | 4.10 |
| HB300 | 3" | 3" | 13.75 |



90° HOSE BARB

| PART # | MALE NPT | BARB | LIST |
|------------|----------|--------|-------|
| HB02590 | 1/4" | 1/4" | 2.20 |
| HB02503890 | 1/4" | 3/8" | 2.20 |
| HB02505090 | 1/4" | 1/2" | 2.20 |
| HB03890 | 3/8" | 3/8" | 2.20 |
| HB05003890 | 1/2" | 3/8" | 2.20 |
| HB05090 | 1/2" | 1/2" | 2.20 |
| HB05007590 | 1/2" | 3/4" | 2.20 |
| HB07505090 | 3/4" | 1/2" | 2.80 |
| HB07590 | 3/4" | 3/4" | 2.35 |
| HB07510090 | 3/4" | 1" | 2.80 |
| HB10007590 | 1" | 3/4" | 3.60 |
| HB10090 | 1" | 1" | 2.95 |
| HB10012590 | 1" | 1 1/4" | 4.40 |
| HB12510090 | 1 1/4" | 1" | 4.40 |
| HB12590 | 1 1/4" | 1 1/4" | 4.40 |
| HB12515090 | 1 1/4" | 1 1/2" | 12.65 |
| HB15012590 | 1 1/2" | 1 1/4" | 12.65 |
| HB15090 | 1 1/2" | 1 1/2" | 10.55 |
| HB20015090 | 2" | 1 1/2" | 13.85 |
| HB20090 | 2" | 2" | 11.55 |
| HB30090 | 3" | 3" | 39.20 |



NIPPLE

| PART # | MALE NPT | LENGTH | LIST |
|------------|----------|--------|-------|
| PNIP-018-S | 1/8" | Short | .85 |
| PNIP-025-S | 1/4" | Short | .95 |
| PNIP-038-S | 3/8" | Short | 1.50 |
| PNIP-050-S | 1/2" | Short | 1.80 |
| PNIP-050-3 | 1/2" | 3" | 2.50 |
| PNIP-075-S | 3/4" | Short | 2.30 |
| PNIP-075-4 | 3/4" | 4" | 2.95 |
| PNIP-075-6 | 3/4" | 6" | 3.30 |
| PNIP-100-S | 1" | Short | 2.70 |
| PNIP-100-4 | 1" | 4" | 3.10 |
| PNIP-100-6 | 1" | 6" | 3.85 |
| PNIP-125-S | 1 1/4" | Short | 2.80 |
| PNIP-125-4 | 1 1/4" | 4" | 3.85 |
| PNIP-125-6 | 1 1/4" | 6" | 4.50 |
| PNIP-150-S | 1 1/2" | Short | 3.90 |
| PNIP-150-4 | 1 1/2" | 4" | 7.75 |
| PNIP-150-6 | 1 1/2" | 6" | 9.25 |
| PNIP-200-S | 2" | Short | 4.30 |
| PNIP-200-4 | 2" | 4" | 9.15 |
| PNIP-200-6 | 2" | 6" | 10.50 |
| PNIP-300-S | 3" | Short | 14.60 |
| PNIP-300-6 | 3" | 6" | 23.25 |
| PNIP-400-S | 4" | Short | 21.70 |



90° SWEEP HOSE BARB

| PART # | MALE NPT | BARB | LIST |
|-----------|----------|--------|-------|
| HB075SW90 | 3/4" | 3/4" | 4.65 |
| HB100SW90 | 1" | 1" | 6.05 |
| HB125SW90 | 1 1/4" | 1 1/4" | 9.60 |
| HB150SW90 | 1 1/2" | 1 1/2" | 10.30 |
| HB200SW90 | 2" | 2" | 10.85 |
| HB300SW90 | 3" | 3" | 43.85 |



STREET ELBOW

| PART # | FEMALE NPT | MALE NPT | LIST |
|---------|------------|----------|-------|
| SE14P | 1/4" | 1/4" | 2.90 |
| SE38P | 3/8" | 3/8" | 2.95 |
| SE12P | 1/2" | 1/2" | 3.00 |
| SE1234P | 3/4" | 1/2" | 3.05 |
| SE34P | 3/4" | 3/4" | 3.40 |
| SE100P | 1" | 1" | 4.35 |
| SE114P | 1 1/4" | 1 1/4" | 6.00 |
| SE112P | 1 1/2" | 1 1/2" | 7.35 |
| SE200P | 2" | 2" | 7.80 |
| SE300P | 3" | 3" | 51.30 |



ELBOW

| PART # | SIZE | LIST |
|---------|--------|-------|
| ELF12P | 1/2" | 2.80 |
| ELF34P | 3/4" | 3.10 |
| ELF100P | 1" | 4.20 |
| ELF114P | 1 1/4" | 5.80 |
| ELF112P | 1 1/2" | 7.30 |
| ELF200P | 2" | 9.80 |
| ELF300P | 3" | 55.05 |

TERREMAX SCH 80 POLYPROPYLENE



REDUCER COUPLING

| PART # | FEMALE NPT | FEMALE NPT | LIST |
|----------|------------|------------|-------|
| RC10075 | 1" | 3/4" | 6.70 |
| RC150100 | 1 1/2" | 1" | 11.35 |
| RC200100 | 2" | 1" | 9.90 |
| RC200150 | 2" | 1 1/2" | 10.05 |
| RC300200 | 3" | 2" | 35.70 |



REDUCER NIPPLE

| PART # | MALE NPT | MALE NPT | LIST |
|----------|----------|----------|-------|
| RN075050 | 3/4" | 1/2" | 2.40 |
| RN10075 | 1" | 3/4" | 2.60 |
| RN150100 | 1 1/2" | 1" | 3.50 |
| RN200150 | 2" | 1 1/2" | 2.90 |
| RN300200 | 3" | 2" | 11.95 |



REDUCER BUSHING

| PART # | MALE NPT | FEMALE NPT | LIST |
|------------|----------|------------|-------|
| RB050038 | 1/2" | 3/8" | 2.50 |
| RB075050 | 3/4" | 1/2" | 2.50 |
| RB100075 | 1" | 3/4" | 2.65 |
| RB125100 | 1 1/4" | 1" | 2.65 |
| RB150125 | 1 1/2" | 1 1/4" | 3.50 |
| RB200075 | 2" | 3/4" | 4.00 |
| RB200150 | 2" | 1 1/2" | 4.00 |
| RB300200HD | 3" | 2" | 22.35 |



COUPLING

| PART # | SIZE | LIST |
|---------|--------|-------|
| CPLG038 | 3/8" | 4.15 |
| CPLG050 | 1/2" | 4.15 |
| CPLG075 | 3/4" | 4.15 |
| CPLG100 | 1" | 4.30 |
| CPLG125 | 1 1/4" | 6.95 |
| CPLG150 | 1 1/2" | 9.60 |
| CPLG200 | 2" | 10.95 |
| CPLG300 | 3" | 31.00 |



TEE

| PART # | SIZE | LIST |
|--------|--------|-------|
| TT14P | 1/4" | 3.55 |
| TT12P | 1/2" | 3.65 |
| TT34P | 3/4" | 4.50 |
| TT100P | 1" | 5.90 |
| TT114P | 1 1/4" | 7.50 |
| TT112P | 1 1/2" | 9.20 |
| TT200P | 2" | 12.20 |
| TT300P | 3" | 51.20 |



45° STREET ELBOW & HOSE BARB

| PART # | FEMALE NPT | MALE NPT | LIST |
|--------------------------------|------------|----------|-------|
| SL15045 | 1 1/2" | 1 1/2" | 11.50 |
| SL20045 | 2" | 2" | 13.60 |
| Female Thread Hose Barb | | | |
| HBF200 | 2" FPT | 2" Barb | 6.20 |



PIPE CAPS

| PART # | SIZE | LIST |
|--------|--------|-------|
| CAP050 | 1/2" | 5.05 |
| CAP075 | 3/4" | 5.05 |
| CAP100 | 1" | 5.05 |
| CAP125 | 1 1/4" | 5.70 |
| CAP150 | 1 1/2" | 7.15 |
| CAP200 | 2" | 8.30 |
| CAP300 | 3" | 29.70 |



PLUG

| PART # | SIZE | LIST |
|---------|--------|-------|
| PLUG050 | 1/2" | 3.15 |
| PLUG075 | 3/4" | 3.15 |
| PLUG100 | 1" | 3.15 |
| PLUG150 | 1 1/2" | 4.20 |
| PLUG200 | 2" | 4.20 |
| PLUG300 | 3" | 16.40 |



TEE WITH GAUGE PORT

| PART # | FEMALE NPT | PORT | LIST |
|----------|------------|------|------|
| TT1214P | 1/2" | 1/4" | 6.15 |
| TT3414P | 3/4" | 1/4" | 8.00 |
| TT10014P | 1" | 1/4" | 9.85 |

See Pressure Gauge Section for available pressure gauges.

TERREMAX® BOLTED POLYPROPYLENE BALL

Features:

- Self-Aligning ball moves freely against the Teflon® seats for smooth operation. The valve opens and closes with little pressure on the handle.
- Teflon® self-lubricating stem bushings and seats cannot stick or bind.
- Ball is diamond turned after molded to make it spherically perfect, which provides precise contact between ball & seat.
- Polypropylene is reinforced with fiberglass for additional strength.
- Stainless Steel Bolts
- Precision molded in polypropylene.
- Viton® "O" rings

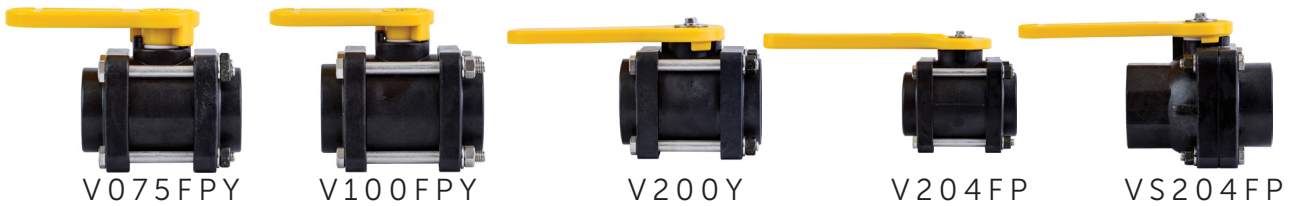

| PART NO. | DESCRIPTION | PORT | PSI | BOX | LIST |
|----------|-------------|--------|-----|-----|-------|
| V050FPY | 1/2" FPT | 3/4" | 150 | 35 | 35.70 |
| V075FPY | 3/4" FPT | 3/4" | 150 | 35 | 35.70 |
| V100Y | 1" FPT | 3/4" | 150 | 35 | 35.70 |
| V100FPY | 1" FPT | 1" | 150 | 24 | 39.35 |
| V125Y | 1 1/4" FPT | 1" | 150 | 24 | 39.35 |
| V125FPY | 1 1/4" FPT | 1 1/2" | 150 | 15 | 48.95 |
| V150FPY | 1 1/2" FPT | 1 1/2" | 150 | 15 | 48.95 |
| V200Y | 2" FPT | 1 1/2" | 150 | 15 | 48.95 |
| V204FPY | 2" FPT | 2" | 100 | 8 | 65.35 |
| VS204FP | 2" FPT | 2" | 100 | 16 | 66.95 |

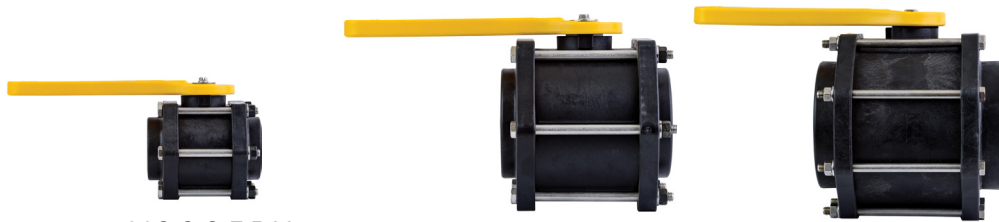

| PART NO. | DESCRIPTION | PORT | PSI | BOX | LIST |
|----------|-------------|--------|-----|-----|--------|
| V200FPY | 2" FPT | 2" | 100 | 8 | 68.95 |
| V300Y | 3" FPT | 2 1/2" | 100 | 8 | 110.85 |
| V300FPY | 3" FPT | 3" | 100 | 6 | 153.95 |
| V400FPY | 4" FPT | 4" | 100 | 2 | 290.50 |

Other configurations are available. MPT x Male Cam Adapter, FPT x Male Cam Adapter, Hose Barb x MPT, MPT x FPT, MPT x MPT, Hose Barb x Female Cam Coupler, Male Cam Adapter x Female Cam Couper, Male Cam Adapter x Hose Barb.

STRAINERS



FEMALE THREADED T STRAINER

| PART # | FEMALE NPT | MESH | LIST |
|-----------|------------|------|-------|
| LST07530 | 3/4" | 30 | 39.30 |
| LST07550 | 3/4" | 50 | 39.30 |
| LST07580 | 3/4" | 80 | 39.30 |
| LST075100 | 3/4" | 100 | 39.30 |
| LST10030 | 1" | 30 | 39.30 |
| LST10050 | 1" | 50 | 39.30 |
| LST10080 | 1" | 80 | 39.30 |
| LST100100 | 1" | 100 | 39.30 |
| LST12530 | 1 1/4" | 30 | 80.95 |
| LST12550 | 1 1/4" | 50 | 80.95 |
| LST12580 | 1 1/4" | 80 | 80.95 |
| LST125100 | 1 1/4" | 100 | 80.95 |
| LST15030 | 1 1/2" | 30 | 80.95 |
| LST15050 | 1 1/2" | 50 | 80.95 |
| LST15080 | 1 1/2" | 80 | 80.95 |
| LST150100 | 1 1/2" | 100 | 80.95 |



FEMALE THREADED Y STRAINER

| PART # | FEMALE NPT | MESH | LIST |
|---------|------------|------|-------|
| LS05020 | 1/2" | 20 | 37.35 |
| LS05040 | 1/2" | 40 | 37.35 |
| LS05080 | 1/2" | 80 | 37.35 |
| LS07520 | 3/4" | 20 | 37.35 |
| LS07540 | 3/4" | 40 | 37.35 |
| LS07580 | 3/4" | 80 | 37.35 |
| LS10020 | 1" | 20 | 38.70 |
| LS10040 | 1" | 40 | 38.70 |
| LS10080 | 1" | 80 | 38.70 |
| LS12520 | 1 1/4" | 20 | 38.70 |
| LS12540 | 1 1/4" | 40 | 38.70 |
| LS12580 | 1 1/4" | 80 | 38.70 |



FEMALE THREADED Y STRAINER

| PART # | FEMALE NPT | MESH | LIST |
|---------|------------|------|-------|
| LS15012 | 1 1/2" | 12 | 77.55 |
| LS15020 | 1 1/2" | 20 | 77.55 |
| LS15030 | 1 1/2" | 30 | 77.55 |
| LS15050 | 1 1/2" | 50 | 77.55 |
| LS15080 | 1 1/2" | 80 | 77.55 |
| LS20020 | 2" | 20 | 77.55 |
| LS20030 | 2" | 30 | 77.55 |
| LS20050 | 2" | 50 | 77.55 |
| LS20080 | 2" | 80 | 77.55 |



QUICK CLEAN Y-STRAINER

| PART # | FEMALE NPT | MESH | LIST |
|------------|------------|-------|--------|
| LSQC2006 | 2" | 6 | 97.55 |
| LSQC20014 | 2" | 14 | 97.55 |
| LSQC20030 | 2" | 30 | 97.55 |
| LSQC20040 | 2" | 40 | 97.55 |
| LSQC20080 | 2" | 80 | 97.55 |
| LSQC300062 | 3" | 1/16" | 526.35 |
| LSQC300125 | 3" | 1/8" | 526.35 |



HEAVY DUTY Y-STRAINER

| PART # | FEMALE NPT | MESH | LIST |
|-----------|------------|------|--------|
| LSHD3006 | 3" | 6 | 410.75 |
| LSHD30012 | 3" | 12 | 410.75 |
| LSHD30020 | 3" | 20 | 410.75 |
| LSHD30040 | 3" | 40 | 410.75 |
| LSHD30080 | 3" | 80 | 410.5 |

• 304 Stainless Steel Screens Reinforced



HEAVY DUTY Y-STRAINER

| PART # | FEMALE NPT | MESH | LIST |
|------------|------------|------|-------|
| LSHD15014 | 1 1/2" | 14 | 91.35 |
| LSHD15020 | 1 1/2" | 20 | 91.35 |
| LSHD15040 | 1 1/2" | 40 | 91.35 |
| LSHD15080 | 1 1/2" | 80 | 91.35 |
| LSHD150100 | 1 1/2" | 100 | 91.35 |
| LSHD20014 | 2" | 14 | 91.35 |
| LSHD20020 | 2" | 20 | 91.35 |
| LSHD20040 | 2" | 40 | 91.35 |
| LSHD20080 | 2" | 80 | 91.35 |
| LSHD200100 | 2" | 100 | 91.35 |



IN-LINE STRAINER CLEAR BOWL

| PART # | FEMALE NPT | MESH | LIST |
|------------|------------|--------|-------|
| LSTM050XXC | 1/2" | 50, 80 | 28.15 |
| LSTM075XXC | 3/4" | 50, 80 | 28.15 |
| LSTM100XXC | 1" | 50, 80 | 51.55 |
| LSTM125XXC | 1 1/4" | 50, 80 | 54.55 |
| LSTM150XXC | 1 1/2" | 50, 80 | 60.95 |

HOSE FITTINGS



PLATED KING NIPPLE

| PART # | SIZE | LIST |
|----------|--------|--------|
| 306-050 | 1/2" | 2.15 |
| 306-075 | 3/4" | 2.20 |
| 306-100 | 1" | 3.00 |
| 306-125 | 1 1/4" | 4.30 |
| 306-150 | 1 1/2" | 4.90 |
| 306-200 | 2" | 6.35 |
| 306-250 | 2 1/2" | 11.35 |
| 306-300 | 3" | 13.00 |
| 306-400 | 4" | 20.05 |
| 306-500 | 5" | 49.75 |
| 306-600 | 6" | 56.65 |
| 306-800 | 8" | 138.30 |
| 306-1000 | 10" | 255.60 |
| 306-1200 | 12" | 347.65 |



PLATED HOSE MENDER

| PART # | SIZE | LIST |
|----------|--------|--------|
| 307-050 | 1/2" | 2.05 |
| 307-075 | 3/4" | 2.65 |
| 307-100 | 1" | 2.85 |
| 307-125 | 1 1/4" | 3.90 |
| 307-150 | 1 1/2" | 5.25 |
| 307-200 | 2" | 7.50 |
| 307-250 | 2 1/2" | 10.90 |
| 307-300 | 3" | 15.20 |
| 307-400 | 4" | 22.60 |
| 307-500 | 5" | 52.35 |
| 307-600 | 6" | 67.85 |
| 307-800 | 8" | 143.80 |
| 307-1000 | 10" | 261.30 |
| 307-1200 | 12" | 384.80 |



ROUND HOLE STRAINERS

| PART # | SIZE | LIST |
|----------------------|--------|--------|
| 309-150 | 1 1/2" | 14.35 |
| 309-200 | 2" | 15.60 |
| 309-250 | 2 1/2" | 20.55 |
| 309-300 | 3" | 22.95 |
| 309-400 | 4" | 25.75 |
| 309-600 | 6" | 75.25 |
| 309-800 | 8" | 148.55 |
| Long Strainer | | |
| 319-150 | 1 1/2" | 14.35 |
| 319-200 | 2" | 15.60 |
| 319-300 | 3" | 22.95 |
| 319-400 | 4" | 25.75 |
| 319-600 | 6" | 75.25 |
| 319-800 | 8" | 148.55 |
| Square Hole Strainer | | |
| 339-150 | 1 1/2" | 14.35 |
| 339-200 | 2" | 15.60 |
| 339-250 | 2 1/2" | 20.55 |
| 339-300 | 3" | 22.95 |
| 339-400 | 4" | 26.00 |
| 339-600 | 6" | 77.60 |



POLYPROPYLENE KING NIPPLE

| PART # | SIZE | LIST |
|---------|--------|-------|
| 326-050 | 1/2" | 1.25 |
| 326-075 | 3/4" | 2.45 |
| 326-100 | 1" | 2.80 |
| 326-125 | 1 1/4" | 3.85 |
| 326-150 | 1 1/2" | 3.55 |
| 326-200 | 2" | 3.90 |
| 326-250 | 2 1/2" | 10.35 |
| 326-300 | 3" | 13.10 |
| 326-400 | 4" | 20.60 |
| 326-500 | 5" | 35.20 |
| 326-600 | 6" | 38.75 |
| 326-800 | 8" | 54.60 |



POLYPROPYLENE HOSE MENDER

| PART # | SIZE | LIST |
|---------|--------|-------|
| 327-050 | 1/2" | 3.00 |
| 327-075 | 3/4" | 3.25 |
| 327-100 | 1" | 3.50 |
| 327-125 | 1 1/4" | 4.50 |
| 327-150 | 1 1/2" | 3.85 |
| 327-200 | 2" | 4.15 |
| 327-250 | 2 1/2" | 8.35 |
| 327-300 | 3" | 10.70 |
| 327-400 | 4" | 16.45 |
| 327-500 | 5" | 34.60 |
| 327-600 | 6" | 38.05 |
| 327-800 | 8" | 55.90 |



POLYPROPYLENE STRAINER

| PART # | SIZE | LIST |
|---------|--------|-------|
| 329-150 | 1 1/2" | 14.15 |
| 329-200 | 2" | 15.70 |
| 329-300 | 3" | 31.60 |

UNIVERSAL FITTINGS



UNIVERSAL HOSE END

| PART # | SIZE | LIST |
|-----------|------|------|
| HE-38-DP | 3/8" | 3.20 |
| HE-50-DP | 1/2" | 3.75 |
| HE-75-DP | 3/4" | 4.25 |
| HE-100-DP | 1" | 5.05 |



UNIVERSAL MALE END

| PART # | SIZE | LIST |
|------------|------|------|
| HME-38-DP | 3/8" | 3.90 |
| HME-50-DP | 1/2" | 4.25 |
| HME-75-DP | 3/4" | 4.35 |
| HME-100-DP | 1" | 5.05 |



UNIVERSAL FEMALE END

| PART # | SIZE | LIST |
|------------|------|------|
| HFE-38-DP | 3/8" | 4.25 |
| HFE-50-DP | 1/2" | 4.25 |
| HFE-75-DP | 3/4" | 4.25 |
| HFE-100-DP | 1" | 4.75 |



BCQ-75B-DP

UNIVERSAL FITTINGS

| PART # | SIZE | LIST |
|------------|-------------------|------|
| BCQ-75B-DP | 1 1/8" to 1 5/16" | 3.70 |
| UW-300-DP | 3 Way Connector | 9.75 |
| UG-2-R | Gasket | .60 |

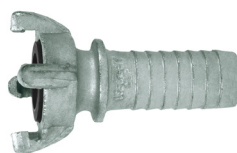

FOUR LUG HOSE END

| PART # | SIZE | LIST |
|--------|--------|-------|
| SFH125 | 1 1/4" | 11.75 |
| SFH150 | 1 1/2" | 12.80 |
| SFH200 | 2" | 16.60 |

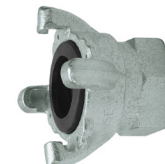

FOUR LUG FEMALE END

| PART # | SIZE | LIST |
|--------|--------|-------|
| SFF125 | 1 1/4" | 9.05 |
| SFF150 | 1 1/2" | 9.20 |
| SFF200 | 2" | 15.50 |

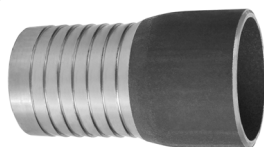

WELD BEVEL BLACK STEEL

| PART # | SIZE | LIST |
|----------|--------|--------|
| 305-100 | 1" | 3.50 |
| 305-125 | 1 1/4" | 4.00 |
| 305-150 | 1 1/2" | 4.50 |
| 305-200 | 2" | 5.20 |
| 305-300 | 3" | 12.85 |
| 305-400 | 4" | 23.00 |
| 305-600 | 6" | 54.85 |
| 305-800 | 8" | 94.85 |
| 305-1000 | 10" | 144.70 |



WELD BEVEL ALUMINUM

| PART # | SIZE | LIST |
|----------|--------|-------|
| 305A-100 | 1" | 4.25 |
| 305A-125 | 1 1/4" | 5.30 |
| 305A-150 | 1 1/2" | 6.45 |
| 305A-200 | 2" | 9.10 |
| 305A-300 | 3" | 23.65 |
| 305A-400 | 4" | 35.95 |
| 305A-500 | 5" | 57.60 |
| 305A-600 | 6" | 70.20 |

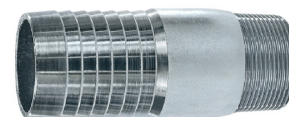

PLATED REDUCING & INCREASING

| PART # | BARB/MPT | LIST |
|----------|---------------------|-------|
| 336-7550 | 3/4" x 1/2" MPT | 3.25 |
| 336-7510 | 3/4" x 1" MPT | 4.05 |
| 336-1075 | 1" x 3/4" MPT | 3.40 |
| 336-1510 | 1 1/2" x 1" MPT | 5.20 |
| 336-1512 | 1 1/2" x 1 1/4" MPT | 5.45 |
| 336-1520 | 1 1/2" x 2" MPT | 7.65 |
| 336-2015 | 2" x 1 1/2" MPT | 7.90 |
| 336-2030 | 2" x 3" MPT | 13.90 |
| 336-3020 | 3" x 2" MPT | 14.35 |

HOSE FITTINGS

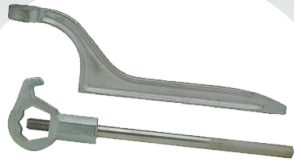

SPANNER WRENCH

| PART # | SIZE | LIST |
|-----------|------------|-------|
| SW-150-DP | 1 1/2" | 4.60 |
| SW-200-DP | 2" | 5.35 |
| SW-250-DP | 2 1/2" | 6.50 |
| SW-300-DP | 3" | 8.10 |
| SW-400-DP | 4" | 10.85 |
| ASW-00-DS | Adjustable | 31.00 |

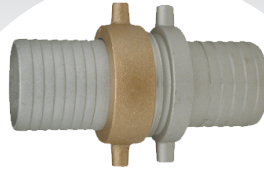

ALUMINUM PIN-LUG SET

| PART # | SIZE | LIST |
|------------|------------|--------|
| PL-150-AB | 1 1/2" NPS | 10.20 |
| PLT-150-AB | 1 1/2" NPT | 18.70 |
| PL-200-AB | 2" NPS | 14.45 |
| PL-250-AB | 2 1/2" NPS | 28.10 |
| PLT-250-AB | 2 1/2" NST | 35.45 |
| PL-300-AB | 3" NPS | 29.70 |
| PL-400-AB | 4" NPS | 55.90 |
| PL-600-AB | 6" NPS | 129.45 |



POLY PIN-LUG SET NPS

| PART # | SIZE | LIST |
|-----------|--------|-------|
| PL-150-PP | 1 1/2" | 11.95 |
| PL-200-PP | 2" | 13.70 |
| PL-300-PP | 3" | 30.00 |
| PL-400-PP | 4" | 55.30 |
| PL-600-PP | 6" | 99.60 |



BRASS HYDRANT ADAPTERS

| PART # | SIZE | LIST |
|-------------|-----------------------------|-------|
| FCR2508G-B | 2 1/2" F NST x 3/4" M GHT | 28.00 |
| FCR2508S-B | 2 1/2" F NST x 3/4" M NPS | 28.00 |
| FCR2508T-B | 2 1/2" F NST x 3/4" M NPT | 28.00 |
| FCR2510N-B | 2 1/2" F NST x 1" M NST | 28.00 |
| FCR25010S-B | 2 1/2" F NST x 1" M NPS | 28.00 |
| FCR25010T-B | 2 1/2" F NST x 1" M NPT | 28.00 |
| FCR2515N-B | 2 1/2" F NST x 1 1/2" M NST | 32.15 |
| FCR2515S-B | 2 1/2" F NST x 1 1/2" M NPS | 28.95 |
| FCR2515T-B | 2 1/2" F NST x 1 1/2" M NST | 28.95 |
| FCR2520S-B | 2 1/2" F NST x 2" M NPS | 30.20 |
| FCR2520T-B | 2 1/2" F NST x 2" M NPT | 30.20 |
| FCR2530S-B | 2 1/2" F NST x 3" M NPS | 81.75 |
| FCR2530T-B | 2 1/2" F NST x 3" M NPT | 81.75 |
| FCR30S25N-B | 3" F NPS x 2 1/2" M NST | 81.75 |

Other Adapters Available. Double Female Swivel, Double Male Female x Male Swivel, Hex Nipple Female x Male, Hex Nipple Double Male, Hex Nipple Double Female and Hex Bushing Male x Female Increaser.



BRASS HOSE NOZZLE

| PART # | SIZE | LIST |
|---------|------------|-------|
| HNT-75 | 3/4" GHT | 14.95 |
| HN-75 | 3/4" NPS | 14.95 |
| HN-100 | 1" NPS | 21.15 |
| HN-125 | 1 1/4" NPS | 40.95 |
| HN-150 | 1 1/2" NPS | 40.95 |
| HNT-150 | 1 1/2" NST | 40.95 |
| HN-200 | 2" NPS | 68.35 |
| HN-250 | 2 1/2" NPS | 71.00 |
| HNT-250 | 2 1/2" NST | 79.25 |



MILL HOSE - SINGLE JACKET 150PSI

| PART # | SIZE | ROLL PER FTS |
|----------|---------------|--------------|
| MILL-150 | 1 1/2" x 100' | 1.75 |
| MILL-200 | 2" x 100' | 2.05 |
| MILL-250 | 2 1/2" x 100' | 2.70 |
| MILL-300 | 3" x 100' | 3.40 |
| MILL-400 | 4" x 100' | 4.40 |

STAINLESS T-BOLT CLAMPS



CLAMP CO STAINLESS STEEL T-BOLT CLAMPS

| PART NO. | MIN. | MAX. | APPLICATION | LIST |
|----------|----------|----------|--------------------------|-------|
| 612-150 | 1 3/8" | 1 1/2" | | 4.65 |
| 612-175 | 1 5/8" | 1 7/8" | 1.5" PVC Layflat/Suction | 5.40 |
| 612-200 | 1 7/8" | 2 1/8" | 2" Poly | 5.40 |
| 612-20 | 2 3/16" | 2 1/2" | 2" Discharge | 4.50 |
| 612-256 | 2 3/8" | 2 11/16" | | 5.65 |
| 612-25 | 2 5/8" | 3" | 2.5" Discharge/Suction | 5.65 |
| 612-30P | 3" | 3 3/8" | 3" PVC/Blue/Red | 4.70 |
| 612-30 | 3 1/8" | 3 1/2" | 6100-30 | 4.75 |
| 612-375 | 3 1/2" | 3 13/16" | | 6.00 |
| 612-40P | 4" | 4 3/8" | 4" PVC/Blue/Red | 5.10 |
| 612-40 | 4 1/8" | 4 1/2" | 6100-40 | 4.75 |
| 612-45 | 4 9/32" | 4 19/32" | 4" Suction | 6.05 |
| 612-60 | 6 1/8" | 6 1/2" | 6" Discharge | 4.60 |
| 712-45 | 4 7/8" | 5 1/4" | 4.5" Pivot Boot | 6.15 |
| 712-50H | 5 1/8" | 5 1/2" | | 11.00 |
| 712-60H | 6 1/8" | 6 1/2" | 6" Pivot Boot | 9.40 |
| 712-68H | 7" | 7 3/8" | 6 5/8" Pivot Boot | 10.95 |
| 712-80H | 8 1/4" | 8 5/8" | 8" Pivot Boot | 10.50 |
| 712-88H | 8 15/16" | 9 3/8" | 8 5/8" Boot | 17.15 |

BOA™ STAINLESS T-BOLT CLAMPS

| PART NO. | MIN. | MAX. | LIST |
|----------|----------|----------|------|
| 613-150 | 1 7/16" | 1 9/16" | 3.00 |
| 613-175 | 1 9/16" | 1 3/4" | 3.00 |
| 613-200 | 1 3/4" | 1 7/8" | 3.00 |
| 613-195 | 1 7/8" | 2 1/16" | 3.00 |
| 613-20 | 2 1/16" | 2 1/4" | 3.15 |
| 613-225 | 2 1/4" | 2 7/16" | 3.15 |
| 613-256 | 2 7/16" | 2 5/8" | 3.15 |
| 613-25 | 2 5/8" | 2 13/16" | 3.00 |
| 613-300 | 2 13/16" | 3 1/16" | 3.60 |
| 613-30P | 3 1/16" | 3 5/16" | 3.60 |
| 613-30 | 3 5/16" | 3 9/16" | 3.60 |
| 613-375 | 3 9/16" | 3 3/4" | 3.80 |
| 613-40P | 4" | 4 1/4" | 4.10 |
| 613-40 | 4 1/4" | 4 1/2" | 4.10 |
| 613-45 | 4 3/4" | 5" | 4.10 |
| 613-50 | 5" | 5 5/16" | 4.10 |
| 613-60 | 6" | 6 7/16" | 4.10 |

Stainless Steel Band w/cadmium plated bolt fine thread

Stainless Steel Band w/cadmium plated bolt coarse thread



HEAVY DUTY PYTHON CLAMPS

| PART # | RANGE | LIST | PART # | RANGE | LIST | PART # | RANGE | LIST |
|----------------------------------|--------------------|------|---------|---------------------|------|---------|-------------------|-------|
| 611-150 | 1 9/16" - 1 11/16" | 3.65 | 611-307 | 1 5/32" - 1 7/32" | 3.50 | 611-321 | 3 5/8" - 3 13/16" | 6.25 |
| 611-20 | 2 1/16" - 2 11/64" | 4.30 | 611-309 | 1 13/32" - 1 1/2" | 3.60 | 611-324 | 4 3/8" - 4 3/4" | 6.65 |
| 611-30 | 3 1/8" - 3 5/16" | 6.15 | 611-311 | 1 23/32" - 1 27/32" | 4.15 | 611-328 | 5 7/8" - 6 3/8" | 11.25 |
| 611-40 | 4 3/32" - 4 3/8" | 6.50 | 611-314 | 2 7/32" - 2 5/16" | 4.35 | 611-329 | 6 3/8" - 6 7/8" | 12.75 |
| All 316 Stainless Steel | | | 611-316 | 2 1/2" - 2 5/8" | 4.50 | 611-333 | 8 3/8" - 8 7/8" | 12.65 |
| Fits Rubber and PVC Layflat Hose | | | 611-320 | 3 3/8" - 3 9/16" | 6.15 | 611-334 | 8 7/8" - 9 3/8" | 12.95 |

CLAMPS



K SERIES CLAMPS

| PART # | SIZE | LIST |
|----------------------------|-------------------|--------|
| 629-00 | Center Punch Tool | 218.15 |
| Stainless Clamps 5/8" Wide | | |
| KS6 | 1 1/2" | 4.10 |
| KS7 | 1 3/4" | 4.35 |
| KS8 | 2" | 4.70 |
| KS9 | 2 1/4" | 5.00 |
| KS10 | 2 1/2" | 5.35 |
| KS11 | 2 3/4" | 5.80 |
| KS12 | 3" | 6.10 |
| KS14 | 3 1/2" | 6.75 |
| KS16 | 4" | 7.50 |
| KS18 | 4 1/2" | 8.10 |
| KS20 | 5" | 8.75 |
| KS24 | 6" | 9.90 |
| KS28 | 7" | 11.30 |
| KS32 | 8" | 12.55 |



SPIRAL CLAMP

| PART # | SIZE | LIST |
|-----------|--------|-------|
| 3028-150 | 1 1/2" | 11.00 |
| 3028-200 | 2" | 17.05 |
| 3028-300 | 3" | 20.50 |
| 3028-400 | 4" | 23.80 |
| 3028-500 | 5" | 31.95 |
| 3028-600 | 6" | 35.60 |
| 3028-800 | 8" | 52.15 |
| 3028-1000 | 10" | 57.20 |
| 3028-1200 | 12" | 66.75 |



DOUBLE BOLT CLAMPS

| PART # | SIZE | LIST |
|----------|---------------|-------|
| 3026-300 | 3.07" - 3.46" | 13.60 |
| 3026-400 | 4.09" - 5.00" | 14.40 |
| 3026-600 | 5.59" - 7.30" | 19.60 |
| 3026-800 | 7.91" - 8.40" | 21.00 |



REBOLT CLAMP

| PART # | SIZE | LIST |
|----------------------|-------------------|-------|
| For Suction | | |
| REB-150-SS | 1.73" - 1.85" | 3.90 |
| REB-200-SS | 2.36" - 2.48" | 4.25 |
| REB-250-SS | 2.91" - 3.11" | 5.15 |
| REB-300-SS | 3.38" - 3.58" | 5.90 |
| REB-400-SS | 4.45" - 4.76" | 6.15 |
| REB-600-SS | 6.37" - 6.85" | 8.40 |
| For Discharge | | |
| RC-150-SD | 1.654" - 1.722" | 3.10 |
| RC-200-SD | 2.047" - 2.200" | 4.40 |
| RC-250-SD | 2.677" - 2.874" | 5.70 |
| RC-300-SD | 3.150" - 3.346" | 6.30 |
| RC-400-SD | 4.095" - 4.409" | 6.65 |
| RC-600-SD | 6.082" - 6.571" | 9.10 |
| RC-800-SD | 7.913" - 8.400" | 9.55 |
| RC-1000-SD | 10.079" - 10.551" | 16.30 |
| RC-1200-SD | 12.126" - 12.598" | 27.10 |
| RC-1400-SD | 14.094" - 14.567" | 27.70 |
| RC-1600-SD | 16.063" - 16.535" | 36.95 |



J SERIES CLAMPS

| PART # | SIZE | LIST |
|----------------------------|--------------|--------|
| 629-WU | Wind Up Tool | 436.20 |
| Stainless Clamps 3/4" Wide | | |
| FLJS227 | 2" | 5.60 |
| FLJS210 | 2 3/4" | 7.20 |
| FLJS211 | 3" | 7.65 |
| FLJS212 | 3 1/2" | 8.30 |
| FLJS213 | 4" | 9.50 |
| FLJS214 | 4 1/2" | 10.10 |
| FLJS215 | 5" | 10.85 |
| FLJS216 | 6" | 10.35 |
| FLJS218 | 7" | 12.05 |
| FLJS219 | 8" | 12.05 |



DOUBLE BOLT CLAMPS

| PART # | SIZE | LIST |
|-----------|-----------------|--------|
| 3DBC-400 | 3.50" - 4.00" | 11.50 |
| 3DBC-463 | 4.06" - 4.44" | 13.10 |
| 3DBC-525 | 4.18" - 5.00" | 14.60 |
| 3DBC-550 | 5.00" - 5.50" | 16.65 |
| 3DBC-600 | 5.50" - 6.06" | 17.85 |
| 3DBC-675 | 6.12" - 6.87" | 19.05 |
| 3DBC-769 | 6.93" - 7.62" | 22.75 |
| 3DBC-818 | 7.68" - 8.18" | 33.20 |
| 3DBC-875 | 8.25" - 8.87" | 34.45 |
| 3DBC-988 | 8.93" - 9.87" | 38.55 |
| 3DBC-1125 | 9.93" - 11.37" | 65.70 |
| 3DBC-1275 | 11.37" - 13.00" | 72.10 |
| 3DBC-1450 | 13.18" - 15.00" | 110.50 |
| 3DBC-1700 | 15.06" - 17.50" | 160.50 |



316 SS SCREW 316 SS BAND

GENERAL PURPOSE CLAMPS



PLATED CARBON SCREW 300 SS BAND

BREEZE POWER-SEAL® CLAMPS

| PART NO. | MIN. | MAX. | MIN. | MAX. | LIST |
|----------|----------|---------|------|--------|------|
| 667-06 | 7/16" | 25/32" | 11 | 20 mm | 2.60 |
| 667-08 | 1/2" | 29/32" | 13 | 23 mm | 2.60 |
| 667-10 | 9/16" | 1 1/16" | 14 | 27 mm | 2.60 |
| 667-12 | 11/16" | 1 1/4" | 17 | 32 mm | 2.60 |
| 667-16 | 13/16" | 1 1/2" | 21 | 38 mm | 2.60 |
| 667-20 | 13/16" | 1 3/4" | 21 | 44 mm | 2.60 |
| 667-24 | 1 1/16" | 2" | 27 | 51 mm | 2.60 |
| 667-28 | 1 5/16" | 2 1/4" | 33 | 57 mm | 2.85 |
| 667-32 | 1 9/16" | 2 1/2" | 40 | 64 mm | 2.85 |
| 667-36 | 1 13/16" | 2 3/4" | 46 | 70 mm | 2.85 |
| 667-40 | 2 1/16" | 3" | 52 | 76 mm | 3.90 |
| 667-44 | 2 5/16" | 3 1/4" | 59 | 83 mm | 3.90 |
| 667-48 | 2 9/16" | 3 1/2" | 65 | 89 mm | 4.00 |
| 667-52 | 2 13/16" | 3 3/4" | 71 | 95 mm | 4.00 |
| 667-56 | 3 1/16" | 4" | 78 | 102 mm | 4.10 |
| 667-60 | 3 5/16" | 4 1/4" | 84 | 108 mm | 4.40 |
| 667-64 | 3 9/16" | 4 1/2" | 91 | 114 mm | 4.40 |
| 667-72 | 1 7/8" | 5" | 48 | 127 mm | 4.40 |
| 667-80 | 2 1/2" | 5 1/2" | 64 | 140 mm | 5.00 |
| 667-96 | 3 5/8" | 6 1/2" | 92 | 165 mm | 5.55 |

BREEZE POWER-SEAL® CLAMPS

| PART NO. | MIN. | MAX. | MIN. | MAX. | LIST |
|----------|----------|---------|------|--------|------|
| 620-06 | 7/16" | 25/32" | 11 | 20 mm | 1.10 |
| 620-08 | 1/2" | 29/32" | 13 | 23 mm | 1.10 |
| 620-10 | 9/16" | 1 1/16" | 14 | 27 mm | 1.10 |
| 620-12 | 11/16" | 1 1/4" | 17 | 32 mm | 1.10 |
| 620-16 | 13/16" | 1 1/2" | 21 | 38 mm | 1.10 |
| 620-20 | 13/16" | 1 3/4" | 21 | 44 mm | 1.15 |
| 620-24 | 1 1/16" | 2" | 27 | 51 mm | 1.15 |
| 620-28 | 1 5/16" | 2 1/4" | 33 | 57 mm | 1.15 |
| 620-32 | 1 9/16" | 2 1/2" | 40 | 64 mm | 1.15 |
| 620-36 | 1 13/16" | 2 3/4" | 46 | 70 mm | 1.70 |
| 620-40 | 2 1/16" | 3" | 52 | 76 mm | 1.70 |
| 620-44 | 2 5/16" | 3 1/4" | 59 | 83 mm | 1.80 |
| 620-48 | 2 9/16" | 3 1/2" | 65 | 89 mm | 1.80 |
| 620-52 | 2 13/16" | 3 3/4" | 71 | 95 mm | 1.80 |
| 620-56 | 3 1/16" | 4" | 78 | 102 mm | 1.80 |
| 620-60 | 3 5/16" | 4 1/4" | 84 | 108 mm | 2.10 |
| 620-64 | 3 9/16" | 4 1/2" | 91 | 114 mm | 2.10 |
| 620-72 | 1 7/8" | 5" | 48 | 127 mm | 2.65 |
| 620-80 | 2 1/2" | 5 1/2" | 64 | 140 mm | 3.20 |
| 620-88 | 3 1/8" | 6" | 79 | 152 mm | 3.30 |
| 620-96 | 3 5/8" | 6 1/2" | 92 | 165 mm | 3.40 |
| 620-104 | 4 1/8" | 7" | 105 | 178 mm | 3.40 |



CLAMP-IT STAINLESS STRAPPING

Stainless Steel Banding. Make any size clamp. 100' per box .030" gauge.

| Part No. | Size & Quantity | List |
|----------|-----------------------|--------|
| 628-10 | 3/8" Strap (.025" g.) | 145.65 |
| 628-20 | 1/2" Strap | 206.35 |
| 628-30 | 5/8" Strap | 249.35 |
| 628-40 | 3/4" Strap | 321.35 |



CLAMP-IT BUCKLES

Stainless Steel Buckles.

| Part No. | Size & Quantity | List |
|----------|--------------------|--------|
| 629-10 | 3/8" (100) | 121.75 |
| 629-20 | 1/2" (100) | 121.75 |
| 629-30 | 5/8" Buckles (100) | 153.85 |
| 629-40 | 3/4" Buckles (100) | 196.55 |



MAKE-A-CLAMP

| PART # | SIZE | LIST |
|---|-------------------|--------|
| Stainless Steel Perforated band worm gear mech. Hex head screw makes any size clamp | | |
| 626-01 | 100' Band | 308.10 |
| 10 Splices 25 Adj. Fasteners | | |
| 626-03 | 25 Adj. Fasteners | 125.00 |

GENUINE BAUER HOSE FITTINGS



HOSE CONNECTOR SET

| PART NO. | SIZE | LIST |
|----------|------|------|
| 1010001 | 2" | |
| 1030001 | 3" | |
| 1050001 | 4" | |
| 1070001 | 6" | |
| 1080001 | 8" | |



BALL

| PART NO. | SIZE | LIST |
|----------|------|------|
| 1011011 | 2" | |
| 1091011 | 3" | |
| 1051011 | 4" | |
| 1071011 | 6" | |
| 1081011 | 8" | |



SOCKET

| PART NO. | SIZE | LIST |
|----------|------|------|
| 1010711 | 2" | |
| 1090711 | 3" | |
| 1050711 | 4" | |
| 1070711 | 6" | |
| 1080711 | 8" | |



LEVER

| PART NO. | SIZE | LIST |
|----------|------|------|
| 1010134 | 2" | |
| 1030134 | 3" | |
| 1050134 | 4" | |
| 1060134 | 6" | |
| 1080134 | 8" | |



FLANGE X BALL

| PART NO. | SIZE | LIST |
|----------|---------|------|
| 1006987W | 4" | |
| 1007005W | 6" | |
| 107003W | 8" | |
| 1417010W | 10" "B" | |
| 1427012W | 12" "B" | |



FLANGE X SOCKET

| PART NO. | SIZE | LIST |
|----------|---------|------|
| 1006986W | 4" | |
| 1007004W | 6" | |
| 1007002W | 8" | |
| 1417310W | 10" "B" | |
| 1427312W | 12" "B" | |



BALL X MPT LESS LEVER

| PART NO. | SIZE | LIST |
|----------|------|------|
| 1010811W | 2" | |
| 1050811W | 4" | |
| 1070811W | 6" | |
| 1070811W | 8" | |



BALL X MPT WITH LEVER

| PART NO. | SIZE | LIST |
|----------|------|------|
| 1090820W | 3" | |
| 1050811L | 4" | |
| 1070811L | 6" | |
| 1080810L | 8" | |



SOCKET X MPT

| PART NO. | SIZE | LIST |
|----------|------|------|
| 1010511W | 2" | |
| 1090521W | 3" | |
| 1050511W | 4" | |
| 1070511W | 6" | |
| 1080511W | 8" | |

*GASKET NOT INCLUDED IN FITTINGS

GENUINE BAUER HOSE FITTINGS



WYE
SOCKET X SOCKET X BALL

| PART NO. | SIZE | LIST |
|----------|---------|------|
| 1050901W | 4" | |
| 1070901W | 6" | |
| 1080901W | 8" | |
| 1410901W | 10" "B" | |
| 1420901W | 12" "B" | |



WYE
BALL X BALL X SOCKET

| PART NO. | SIZE | LIST |
|----------|------|------|
| 1050902W | 4" | |
| 1070902W | 6" | |
| 1080902W | 8" | |



TEE
SOCKET X BALL X BALL

| PART NO. | SIZE | LIST |
|----------|---------|------|
| 1051701W | 4" | |
| 1071701W | 6" | |
| 1081701W | 8" | |
| 1411701W | 10" "B" | |
| 1421701W | 12" "B" | |



TEE
SOCKET X SOCKET X BALL

| PART NO. | SIZE | LIST |
|----------|------|------|
| 1051801W | 4" | |
| 1071801W | 6" | |
| 1081801W | 8" | |



TEE
BALL X BALL X SOCKET

| PART NO. | SIZE | LIST |
|----------|------|------|
| 1051901W | 4" | |
| 1071901W | 6" | |
| 1081901W | 8" | |



TEE
SOCKET X BALL X SOCKET

| PART NO. | SIZE | LIST |
|----------|------|------|
| 1052001W | 4" | |
| 1072001W | 6" | |
| 1082001W | 8" | |



90° ELBOW

| PART NO. | SIZE | LIST |
|----------|---------|------|
| 1051101W | 4" | |
| 1071101W | 6" | |
| 1081101W | 8" | |
| 1411101W | 10" "B" | |
| 1421101W | 12" "B" | |



45° ELBOW

| PART NO. | SIZE | LIST |
|----------|---------|------|
| 1051101W | 4" | |
| 1071101W | 6" | |
| 1081101W | 8" | |
| 1411101W | 10" "B" | |
| 1421101W | 12" "B" | |



GASKET

| PART NO. | SIZE | LIST |
|----------|------|-------|
| 436-20 | 2" | 3.20 |
| 436-30 | 3" | 2.75 |
| 436-40 | 4" | 4.35 |
| 436-60 | 6" | 6.45 |
| 436-80 | 8" | 6.50 |
| 436-100 | 10" | 9.75 |
| 436-120 | 12" | 28.15 |

*GASKET NOT INCLUDED IN FITTINGS

HOSE BIB AND HOSE END FITTINGS



BRASS GARDEN VALVE

| PART # | INLET/OUTLET | LIST |
|----------|---------------------|-------|
| GV-050 | 1/2" FPT x 3/4" MHT | 13.30 |
| GV-075 | 3/4" FPT x 3/4" MHT | 13.30 |
| GV-100 | 1" FPT x 3/4" MHT | 14.00 |
| GV-111 | 1" FPT x 1" MHT | 18.90 |
| GV-050IN | 1/2" FPT x 3/4" MHT | 13.30 |
| GV-075IN | 3/4" FPT x 3/4" MHT | 13.30 |
| GV-100IN | 1" FPT x 3/4" MHT | 14.00 |



GARDEN VALVE LOOSE KEY

| PART # | INLET/OUTLET | LIST |
|-----------|------------------------|-------|
| GV-050L | 1/2" FPT x 3/4" MHT | 14.70 |
| GV-075L | 3/4" FPT x 3/4" MHT | 14.70 |
| GV-100L | 1" FPT x 3/4" MHT | 15.60 |
| GV-050INL | 1/2" FPT x 3/4" MHT | 14.70 |
| GV-075INL | 3/4" FPT x 3/4" MHT | 14.70 |
| GV-100INL | 1" FPT x 3/4" MHT | 15.60 |
| LKGV | Garden Valve Loose Key | 2.25 |



ANTI-SIPHON GARDEN VALVE

| PART # | SIZE | LIST |
|------------|---------------------|-------|
| GVF-050 | 1/2" FPT x 3/4" MHT | 15.60 |
| GVF-075 | 3/4" FPT x 3/4" MHT | 15.60 |
| GVF-100 | 1" FPT x 3/4" MHT | 17.20 |
| Lead Free | | |
| GVF-050-LF | 1/2" FPT x 3/4" MHT | 18.70 |
| GVF-075-LF | 3/4" FPT x 3/4" MHT | 18.70 |
| GVF-100-LF | 1" FPT x 3/4" MHT | 21.70 |



ANTI SIPHON INVERTED GARDEN VALVE

| PART # | INLET/OUTLET | LIST |
|-----------|---------------------|-------|
| GVF-050IN | 1/2" FPT x 3/4" MHT | 15.60 |
| GVF-075IN | 3/4" FPT x 3/4" MHT | 15.60 |
| GVF-100IN | 1" FPT x 3/4" MHT | 17.20 |



ANTI SIPHON GARDEN VALVE LOOSE KEY

| PART # | INLET/OUTLET | LIST |
|----------|---------------------|-------|
| GVF-050L | 1/2" FPT x 3/4" MHT | 17.20 |
| GVF-075L | 3/4" FPT x 3/4" MHT | 17.20 |
| GVF-100L | 1" FPT x 3/4" MHT | 18.85 |



ANTI SIPHON INVERTED LOOSE KEY

| PART # | INLET/OUTLET | LIST |
|------------|---------------------|-------|
| GVF-050INL | 1/2" FPT x 3/4" MHT | 17.20 |
| GVF-075INL | 3/4" FPT x 3/4" MHT | 17.20 |
| GVF-100INL | 1" FPT x 3/4" MHT | 18.85 |

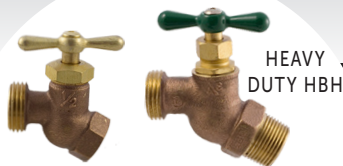

HEAVY DUTY HBH

HOSE BIBB T-HANDLE

| PART # | SIZE | LIST |
|----------|---------------------|-------|
| HB-050M | 1/2" MPT x 3/4" MHT | 8.00 |
| HB-075M | 3/4" MPT x 3/4" MHT | 8.75 |
| HB-050F | 1/2" FPT x 3/4" MHT | 8.00 |
| HB-075F | 3/4" FPT x 3/4" MHT | 8.75 |
| HBH-050M | 1/2" MPT x 3/4" MHT | 12.00 |
| HBH-075M | 3/4" MPT x 3/4" MHT | 12.60 |
| HBH-050F | 1/2" FPT x 3/4" MHT | 12.00 |
| HBH-075F | 3/4" FPT x 3/4" MHT | 12.60 |



HBL-050 HB-50ML HBH-075S

HOSE BIB LONG NOSE

| PART # | SIZE | LIST |
|----------|------------------------------------|-------|
| HBL-050 | 1/2" MPT x 3/4" MHT | 9.25 |
| HBL-075 | 3/4" MPT x 3/4" MHT | 10.20 |
| HB-050ML | 1/2" MPT x 3/4" MHT | 10.20 |
| HB-075ML | 3/4" MPT x 3/4" MHT | 11.55 |
| HB-050FL | 1/2" FPT x 3/4" MHT | 10.20 |
| HB-075FL | 3/4" FPT x 3/4" MHT | 11.55 |
| HBH-075S | 1/2" ID x 3/4" OD Sweat x 3/4" MHT | 12.60 |
| HBH-058S | 1/2" ID x 5/8" OD Sweat x 3/4" MHT | 14.30 |



HOSE BIBBS QUARTER TURN

| PART # | SIZE | LIST |
|------------|------------------------------------|-------|
| HBQT-050M | 1/2" MPT x 3/4" MHT | 29.95 |
| HBQT-075M | 3/4" MPT x 3/4" MHT | 32.00 |
| HBQT-050F | 1/2" FPT x 3/4" MHT | 29.25 |
| HBQT-075F | 3/4" FPT x 3/4" MHT | 30.10 |
| HBQT-075S | 1/2" ID x 3/4" OD Sweat x 3/4" MHT | 31.50 |
| HBSQT-050F | 1/2" Sillcock x 3/4" MHT | 31.50 |
| HBSQT-075F | 3/4" Sillcock x 3/4" MHT | 31.50 |

BRASS VALVES



AS-075 ASUW-075

ANTI-SIPHON ASSEMBLY

| PART # | SIZE | LIST |
|----------|---------------|-------|
| AS-075 | 3/4" Cross | 42.85 |
| ASU-075 | 3/4" w/ Union | 51.30 |
| ASW-075 | 3/4" Wheel | 44.65 |
| ASUW-075 | 3/4" w/ Union | 50.75 |
| AS-100 | 1" Cross | 54.60 |
| ASU-100 | 1" w/ Union | 64.05 |
| ASW-100 | 1" Wheel | 54.40 |
| ASUW-100 | 1" w/ Union | 64.95 |



AA-075 AA-SM-075

AUTOMATIC VALVES

| PART # | SIZE | LIST |
|-----------|---------------|-------|
| AA-075 | 3/4" Actuator | 92.15 |
| AA-100 | 1" Actuator | 97.20 |
| AA-SM-075 | 3/4" Small | 86.80 |
| AA-SM-100 | 1" Small | 90.10 |



GLOBE VALVE

| PART # | SIZE | LIST |
|---------|--------|-------|
| GLB-050 | 1/2" | 13.40 |
| GLB-075 | 3/4" | 17.90 |
| GLB-100 | 1" | 24.15 |
| GLB-125 | 1 1/4" | 36.10 |
| GLB-150 | 1 1/2" | 50.45 |
| GLB-200 | 2" | 75.05 |



ANGLE VALVE

| PART # | SIZE | LIST |
|--------|--------|--------|
| AV-075 | 3/4" | 26.15 |
| AV-100 | 1" | 34.50 |
| AV-125 | 1 1/4" | 87.45 |
| AV-150 | 1 1/2" | 109.95 |
| AV-200 | 2" | 134.50 |



STRAIGHT VALVE

| PART # | SIZE | LIST |
|--------|--------|--------|
| SV-075 | 3/4" | 32.40 |
| SV-100 | 1" | 45.20 |
| SV-125 | 1 1/4" | 96.10 |
| SV-150 | 1 1/2" | 138.25 |
| SV-200 | 2" | 221.55 |

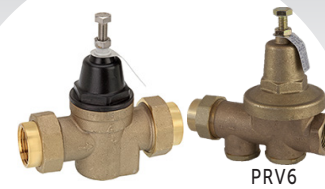

PRV6

PRESSURE REGULATORS LEAD FREE

| PART # | SIZE | LIST |
|------------------------|------------------|--------|
| Single Union 25-75 psi | | |
| PRV3-075-LF | 3/4" w/ Union | 90.10 |
| PRV3-100-LF | 1" w/ Union | 115.65 |
| Double Union | | |
| PRV4-075-LF | 3/4" w/ Unions | 106.45 |
| PRV4-100-LF | 1" w/ Unions | 131.00 |
| PRV4-125-LF | 1 1/4" w/ Unions | 343.90 |
| PRV4-150-LF | 1 1/2" w/ Unions | 409.40 |
| PRV4-200-LF | 2" w/ Unions | 573.15 |
| FPT x Solder Union | | |
| PRV6-075-LF | 3/4" | 163.75 |
| PRV6-100-LF | 1" | 245.63 |

- Adjustable outlet pressure range: 25–75 PSI
- Cold water pressure 300 PSI
- Service temperature 180° F
- Inlet water pressure 300 PSI
- Maximum flow capacity*: 3/4" - 30 GPM,



ATMOSPHERIC VACUUM BREAKER

| PART # | SIZE | LIST |
|---------|--------|--------|
| AVB-075 | 3/4" | 23.80 |
| AVB-100 | 1" | 35.10 |
| AVB-125 | 1 1/4" | 69.05 |
| AVB-150 | 1 1/2" | 80.40 |
| AVB-200 | 2" | 149.60 |



STP-050X

LOG LIGHTER & STOP VALVE

| PART # | SIZE | LIST |
|----------|---------------|-------|
| LLSV-050 | 1/2" Straight | 21.95 |
| LLAV-050 | 1/2" Angle | 23.05 |
| LLSV-075 | 3/4" Straight | 33.80 |
| STP-050X | 1/2" Stop | 10.35 |
| STP-075X | 3/4" Stop | 11.55 |

BRASS VALVES



SWING CHECK

| PART # | SIZE | LIST |
|--------|--------|--------|
| CV-050 | 1/2" | 11.40 |
| CV-075 | 3/4" | 14.55 |
| CV-100 | 1" | 19.25 |
| CV-125 | 1 1/4" | 32.25 |
| CV-150 | 1 1/2" | 41.45 |
| CV-200 | 2" | 67.90 |
| CV-250 | 2 1/2" | 116.85 |
| CV-300 | 3" | 167.90 |
| CV-400 | 4" | 256.75 |



SWING CHECK LEAD FREE

| PART # | SIZE | LIST |
|-----------|--------|-------|
| CV-050-LF | 1/2" | 13.30 |
| CV-075-LF | 3/4" | 17.60 |
| CV-100-LF | 1" | 19.25 |
| CV-125-LF | 1 1/4" | 32.25 |
| CV-150-LF | 1 1/2" | 48.30 |
| CV-200-LF | 2" | 79.75 |



WING CURB STOP VALVE NO LEAD

| PART # | SIZE | LIST |
|---------|--------|--------|
| BCS-075 | 3/4" | 63.65 |
| BCS-100 | 1" | 122.50 |
| BCS-125 | 1 1/4" | 162.20 |
| BCS-150 | 1 1/2" | 318.75 |
| BCS-200 | 2" | 412.45 |

- 1 1/4" to 2" 80 p.s.i. 80°F
- 1/2" to 1" 100 p.s.i. 100°F
- Conforms to AWWA C 800



IN-LINE SPRING CHECK LEAD FREE

| PART # | SIZE | LIST |
|------------|--------|-------|
| CVI-050-LF | 1/2" | 10.85 |
| CVI-075-LF | 3/4" | 15.25 |
| CVI-100-LF | 1" | 20.30 |
| CVI-125-LF | 1 1/4" | 34.30 |
| CVI-150-LF | 1 1/2" | 38.85 |
| CVI-200-LF | 2" | 76.25 |



BRASS FOOT VALVES NO LEAD

| PART # | SIZE | LIST |
|---------|--------|--------|
| FVNL50 | 1/2" | 8.75 |
| FVNL75 | 3/4" | 12.30 |
| FVNL100 | 1" | 16.65 |
| FVNL125 | 1 1/4" | 23.35 |
| FVNL150 | 1 1/2" | 32.60 |
| FVNL200 | 2" | 55.25 |
| FVNL300 | 3" | 203.25 |
| FVNL400 | 4" | 367.35 |



BRASS WYE STRAINER NO LEAD

| PART # | SIZE | LIST |
|---------|--------|--------|
| BYS-050 | 1/2" | 18.60 |
| BYS-075 | 3/4" | 30.45 |
| BYS-100 | 1" | 46.05 |
| BYS-125 | 1 1/4" | 66.70 |
| BYS-150 | 1 1/2" | 92.55 |
| BYS-200 | 2" | 150.80 |
| BYS-250 | 2 1/2" | 270.55 |
| BYS-300 | 3" | 429.00 |

MERRILL FROST FREE HYDRANTS

ANY FLOW® Frost Proof Yard Hydrant



Standard 3/4" ANY FLOW®

Inlet - 3/4" NPT in Heavy Casting
 Outlet - 3/4" Hose Thread Adapter
 Stainless Steel Operating Stem Thru Packing
 Automatic Self-Adjusting Plunger
 1" Galvanized Stand Pipe
 7/16" Galvanized Operating Rod

| PART # | PIPE CONNECTION X PIPE DEPTH | PIPE SIZE | OVERALL LENGTH | WEIGHT | LIST |
|--------|---------------------------------|--------------|-------------------|--------|--------|
| AF7502 | 3/4" X 2' | 1" Galv. | 57.5" | 15.5 | 196.80 |
| AF7503 | 3/4" x 3' | 1" Galv. | 69.5" | 17.5 | 214.50 |
| AF7504 | 3/4" x 4' | 1" Galv. | 81.5" | 19.5 | 232.25 |
| AF7505 | 3/4" x 5' | 1" Galv. | 93.5" | 21.5 | 249.15 |

High Capacity 1" ANY FLOW®

Inlet - 1" NPT in Heavy Casting
 Outlet - 3/4" Hose Thread Adapter
 Stainless Steel Operating Stem Thru Packing
 Automatic Self-Adjusting Plunger
 1-1/4" Galvanized Stand Pipe
 7/16" Galvanized Operating Rod

| High Capacity 1" | | | | | |
|------------------|---------------------------------|--------------|-------------------|--------|--------|
| PART # | PIPE CONNECTION X PIPE DEPTH | PIPE SIZE | OVERALL LENGTH | WEIGHT | LIST |
| AF103 | 1" x 3' | 1 1/4" Galv. | 69.5" | 21.0 | 279.55 |
| AF104 | 1" x 4' | 1 1/4" Galv. | 81.5" | 23.5 | 298.95 |
| AF105 | 1" x 5' | 1 1/4" Galv. | 93.5" | 26.0 | 317.55 |
| AF106 | 1" x 6' | 1 1/4" Galv. | 105.5" | 28.5 | 336.95 |

C-1000 Frost Proof Yard Hydrant



Standard 3/4" C-1000

Inlet - 3/4" NPT in Heavy Casting
 Outlet - 3/4" Hose Thread Adapter
 Stainless Steel Operating Stem Thru Packing
 Self-Lubricating Plunger
 1" Galvanized Stand Pipe
 3/8" Operating Rod

| PART # | PIPE CONNECTION X PIPE DEPTH | PIPE SIZE | OVERALL LENGTH | WEIGHT | LIST |
|--------|---------------------------------|--------------|-------------------|--------|--------|
| C7502 | 3/4" X 2' | 1" Galv. | 56.5" | 13.0 | 147.20 |
| C7503 | 3/4" x 3' | 1" Galv. | 68.5" | 15.0 | 159.15 |
| C7504 | 3/4" x 4' | 1" Galv. | 80.5" | 17.0 | 171.15 |
| C7505 | 3/4" x 5' | 1" Galv. | 92.5" | 19.0 | 182.25 |

High Capacity 1" C-1000

Inlet - 1" NPT in Heavy Casting
 Outlet - 3/4" Hose Thread Adapter
 Stainless Steel Operating Stem Thru Packing
 Self-Lubricating Plunger
 1" Galvanized Stand Pipe
 3/8" Operating Rod

| High Capacity 1" | | | | | |
|------------------|---------------------------------|--------------|-------------------|--------|--------|
| PART # | PIPE CONNECTION X PIPE DEPTH | PIPE SIZE | OVERALL LENGTH | WEIGHT | LIST |
| C103 | 1" x 3' | 1" Galv. | 68.5" | 15.0 | 162.60 |
| C104 | 1" x 4' | 1" Galv. | 80.5" | 17.0 | 173.70 |
| C105 | 1" x 5' | 1" Galv. | 92.5" | 19.0 | 186.55 |
| C106 | 1" x 6' | 1" Galv. | 104.5" | 21.0 | 197.65 |

R-6000 Frost Proof Yard Hydrant



High Capacity 1" R-6000

Inlet - 1" NPT in Heavy Casting
 Outlet - 3/4" Hose Thread Adapter
 Stainless Steel Operating Stem Thru Packing
 Self-Lubricating Plunger
 1" Galvanized Stand Pipe
 3/8" Operating Rod

| PART # | PIPE CONNECTION X PIPE DEPTH | PIPE SIZE | OVERALL LENGTH | WEIGHT | LIST |
|--------|---------------------------------|--------------|-------------------|--------|--------|
| R102 | 1" X 2' | 1" Galv. | 58.5" | 15.5 | 208.60 |
| R103 | 1" x 3' | 1" Galv. | 70.5" | 17.5 | 219.60 |
| R104 | 1" x 4' | 1" Galv. | 82.5" | 19.5 | 231.40 |
| R105 | 1" x 5' | 1" Galv. | 94.5" | 21.5 | 244.05 |

High Capacity 1" R-6000 No-Lead

Inlet - 1" NPT in Heavy No-Lead Casting
 Outlet - 3/4" No-Lead Hose Thread Adapter
 Stainless Steel Operating Stem Thru Packing
 Self-Lubricating Plunger
 No-Lead Valve Body
 1" Galvanized Stand Pipe
 3/8" Operating Rod

| High Capacity No-Lead 1" | | | | | |
|--------------------------|---------------------------------|--------------|-------------------|--------|--------|
| PART # | PIPE CONNECTION X PIPE DEPTH | PIPE SIZE | OVERALL LENGTH | WEIGHT | LIST |
| RNL103 | 1" x 3' | 1" Galv. | 70.5" | 17.5 | 225.50 |
| RNL104 | 1" x 4' | 1" Galv. | 82.5" | 19.5 | 237.30 |
| RNL105 | 1" x 5' | 1" Galv. | 94.5" | 21.5 | 249.15 |
| RNL106 | 1" x 6' | 1" Galv. | 106.5" | 23.5 | 260.95 |

B-7000 Frost Proof Yard Hydrant



B-7000 No-Lead

Inlet - 1" NPT
 Outlet - 3/4" Hose Thread
 Heavy Cast Iron Head
 1" Galvanized Pipe
 Heavy Cast Brass or No-Lead Brass Valve
 Body

| PART # | PIPE CONNECTION X PIPE DEPTH | PIPE SIZE | OVERALL LENGTH | WEIGHT | LIST |
|--------|---------------------------------|--------------|-------------------|--------|--------|
| BNL102 | 1" X 2' | 1" Galv. | 51.5" | 13.0 | 110.40 |
| BNL103 | 1" x 3' | 1" Galv. | 63.5" | 15.3 | 115.95 |
| BNL104 | 1" x 4' | 1" Galv. | 75.5" | 17.0 | 121.10 |
| BNL105 | 1" x 5' | 1" Galv. | 87.5" | 19.0 | 126.65 |
| BNL106 | 1" x 6' | 1" Galv. | 99.5" | 21.0 | 131.80 |

BA Series BigAI® Differential Tank/Reservoir Valve

Designed as a variable level, diaphragm activated, and full flow valve, the BigAI® is used in large pump-fed water tanks or reservoirs, main or storage tanks, or as a control valve backup in rainwater harvesting.

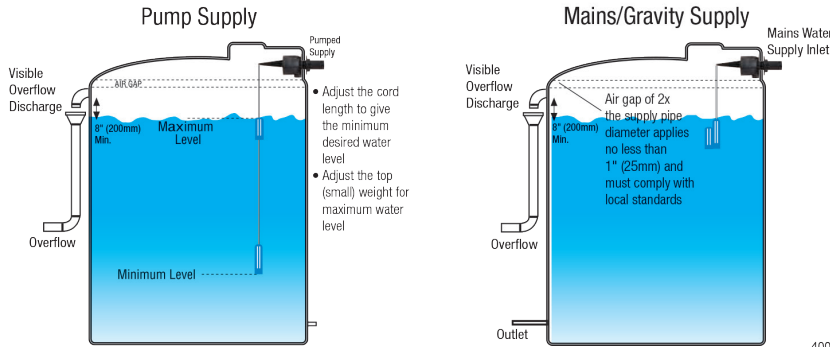

APEX VALVES
A WATTS Brand

BigAI Series

| PART # | MODEL | SIZE | LIST |
|----------|-------|--------|--------|
| 88005611 | BA114 | 1 1/4" | 176.00 |
| 88005612 | BA112 | 1 1/2" | 178.00 |
| 88005613 | BA2 | 2" | 233.00 |

Features for BigAI and PumpBuddy®

- Full flow, high performance - average output 225gpm @ 60psi. Max 400gpm @ 175psi
- Durable – fiberglass reinforced nylon and acetal
- Diaphragm activated – full on/off and soft closing, no water hammer
- Single or variable adjustable level weighted floats maintain water level in tank
- Long tail
- Saves electricity & increases pump life
- UV stabilized
- Patented self cleaning mechanism
- Serviceable – kit available

APEX BigAI Valve Flow Rate

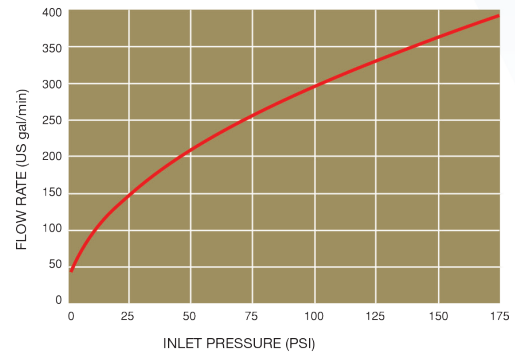

APEX VALVES
A WATTS Brand

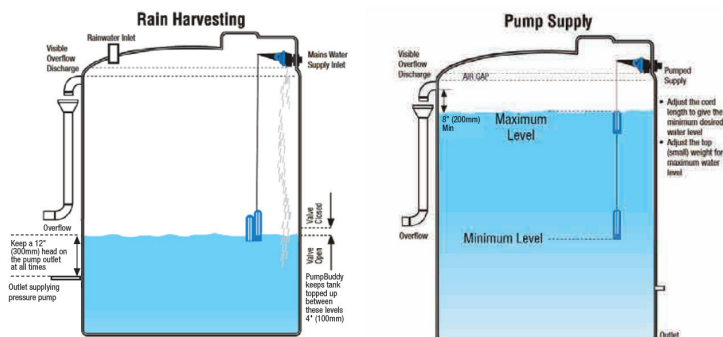

APEX PumpBuddy Valve

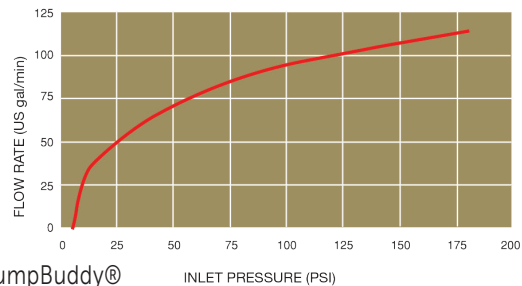

PumpBuddy®

| PART # | MODEL | SIZE | LIST |
|----------|--------|--------|-------|
| 88005614 | PB34 | 3/4" | 82.00 |
| 88005615 | PB34LT | 3/4" | 78.00 |
| 88005616 | PB1 | 1" | 83.00 |
| 88005617 | PB1LT | 1" | 87.00 |
| 88005618 | PB114 | 1 1/4" | 75.00 |

PB Series PumpBuddy® Differential Tank Valve

Designed as a diaphragm activated, variable level, full flow valve, the PumpBuddy is used in pump-fed water tanks or reservoirs, main or storage tanks, or as a control valve backup in rainwater harvesting.

**RA Series
 RainAid® Rainwater
 Retention Tank Valve**

RainAid Valve is designed to connect to the main water supply on a rainwater collection tank to provide a backup supply of water in the event that demand exceeds rain supply.

- Adjustable water levels save electricity and increase pump life
- Full flow diaphragm activated valve
- Long tail (no tank fitting required)
- Fully serviceable (kit available)

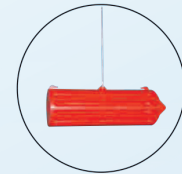
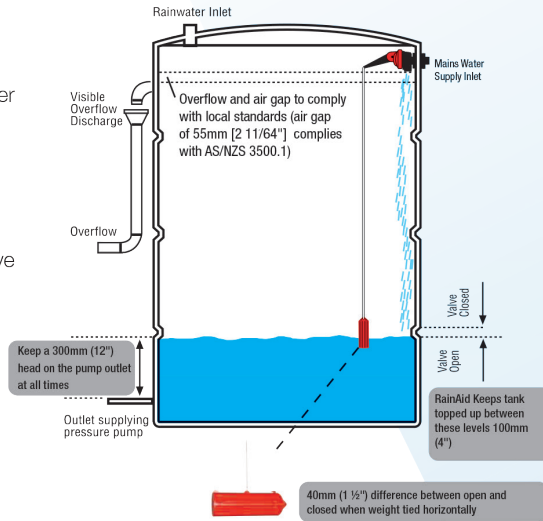

40mm (1 1/2") difference between open and closed when weight tied horizontally

RA Series

**Reservoir Valve
 Water Tank & Reservoir Valve**

This large acetyl sleeve, high-volume flow valve is used for controlling water flow into reservoirs and large header tanks.

- Full flow operation
- Large UV-stabilized acetyl construction sleeve body
- Dezincification resistant brass lever
- No metal valve seat corrosion
- Float arm is fully adjustable
- Fully serviceable



Reservoir Valve

| PART # | MODEL | SIZE | LIST |
|----------|--------|--------|-------|
| 88005648 | RES114 | 1 1/4" | 97.00 |
| 88005649 | RES112 | 1 1/2" | 97.00 |
| 88005650 | RES2 | 2" | 97.00 |

XF Series XtraFlo® Armless Diaphragm Trough Valve

The XtraFlo compact armless diaphragm valve with full-flow and fast fill performance is designed for use with medium and large troughs with high demand. This armless valve reduces damage from livestock, is easily serviced, and includes three options for mounting. Made from UV stabilized fiberglass reinforced nylon, the XtraFlo is durable and built to last.

- Compact diaphragm valve – full on/off
- Full-fill, fast fill – average output of 80gpm @ 60psi
- Armless valve – less susceptible to damage
- Bottom, side or top mount
- Long and short tail options
- UV stabilized and corrosion resistant
- 1" water level differential open/close – reduces pump overload
- Patented self cleaning mechanism
- Serviceable – kit available

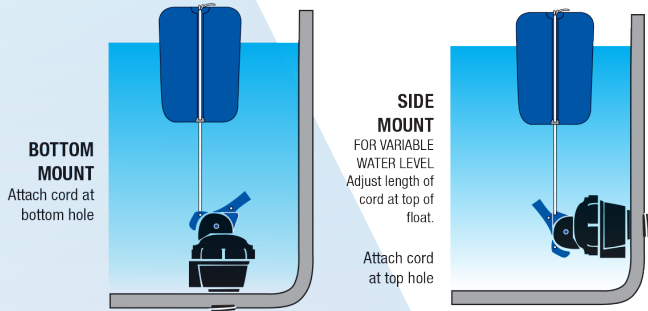

XtraFlo® Top Entry

The XtraFlo Top Entry is designed for compact top entry installation. It includes the same features, operation, and flow as the armless XtraFlo valve.

| XF Series Top Entry | | | |
|---------------------|----------|--------|-------|
| PART # | MODEL | SIZE | LIST |
| 88005625 | XF34LTTE | 3/4" | 77.00 |
| 88005626 | XF1LTTE | 1" | 78.00 |
| 88005627 | XFTE34 | 3/4" | 68.00 |
| 88005628 | XFTE1 | 1" | 68.00 |
| 88005629 | XFTE114 | 1 1/4" | 69.00 |

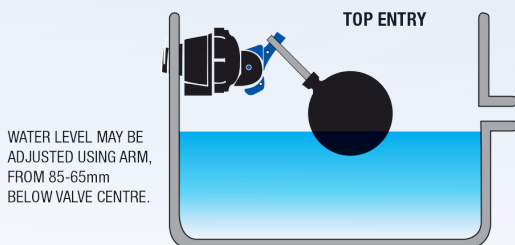

| XF Series | | | |
|-----------|--------|----------------|-------|
| PART # | MODEL | SIZE | LIST |
| 88005620 | XF134 | 3/4" & 1" | 63.00 |
| 88005621 | XF114 | 1 1/4" | 58.00 |
| 88005623 | XF34LT | 3/4" Long Tail | 63.00 |
| 88005624 | XF1LT | 1" Long Tail | 63.00 |



Top Entry Version
Air gap provides
back-flow prevention

APEX XtraFlo Flow Rate

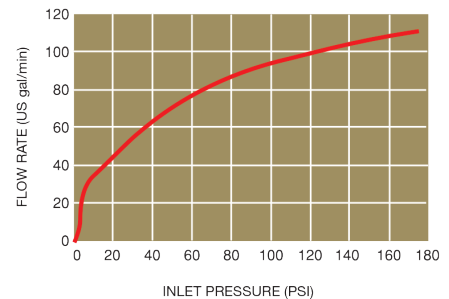

XS Series Xcess™ Fast-fill Trough Valve

Xcess valve is designed for the fast filling of large troughs. Xcess functions without tools and can be easily serviced while in place, making it an easy-to-maintain and reliable solution. Its unique camlock compatible adapter allows for convenient water supply connection for other jobs on the farm.

- Plunger style valve
- High flow fast fill valve – average 80gpm @ 70psi
- Camlock compatible adapter
- Easily serviced – while in line and no tools
- Long and short tail versions
- Shut off pin
- UV Stabilized and corrosion resistant
- Working pressure 0-175psi

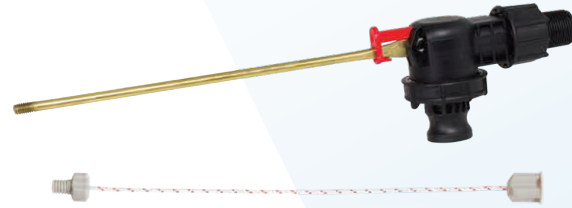

XS Series

| PART # | MODEL | SIZE | LIST |
|----------|--------|---------------------|-------|
| 88005630 | XS134 | 1" x 3/4" | 36.00 |
| 88005631 | XS134T | 1" x 3/4" Long Tail | 39.00 |

Xcess Trough Valve Flow Rate

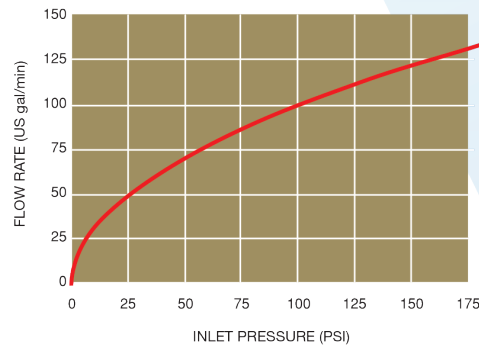

No tools required to service



Service without removing arm

UF Series UltraFlo™ Sleeve Trough Valve

It can be serviced in place and does not require the use of tools.

- Ultra high flow rate 97gpm @ 175psi
- Made from UV stabilized and non-corrosive materials
- Easily serviced – plunger removable without disconnecting valve or arm



UltraFlow Valve Flow Rate

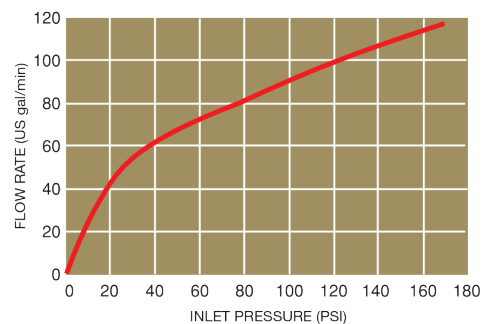

UF Series



AP Series Acetyl Full Flow Sleeve Valve

The full flow acetyl sleeve valve is designed for filling medium-sized troughs. It provides medium to high demand flow rates of 82 gal/min. This acetyl full flow valve is a cost-effective alternative to a full flow brass valve.

- Full flow design
- Fully serviceable
- Working pressure 0-175psi – ideal for gravity fed systems
- Average flow rate 50gpm @ 60psi
- Long tail options
- UV stabilized and non-corrosive



| AP Series PART # | MODEL | SIZE | LIST |
|------------------|----------|-----------|-------|
| 88005635 | AP34-1 | 3/4" x 1" | 31.00 |
| 88005636 | AP1/2 | 1/2" | 28.00 |
| 88005637 | APCLT3/4 | 3/4" | 29.00 |
| 88005638 | APCLT1 | 1" | 32.00 |

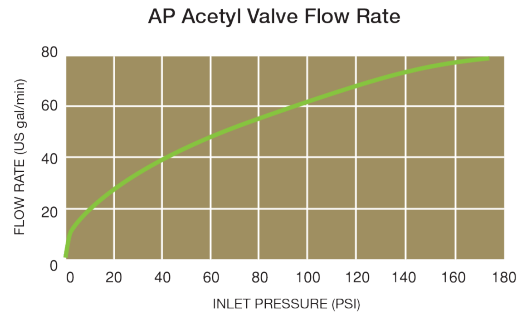

SS Series SpaceSaver

The SpaceSaver compact acetyl valve is designed for small, individual troughs and drinkers. It is composed of non-corrosive materials, making it an ideal solution for hydroponic applications.

- Non-corrosive materials – ideal for hydroponic applications
- Float can be rotated to fit in small spaces
- Plunger activated
- Provided with long tail and back nut – no tank fitting required.
- Working pressure 0-120psi



| SS Series PART # | MODEL | SIZE | LIST |
|------------------|---------|------|-------|
| 88005643 | SS12 US | 1/2" | 29.00 |
| 88005644 | SS34 US | 3/4" | 32.00 |

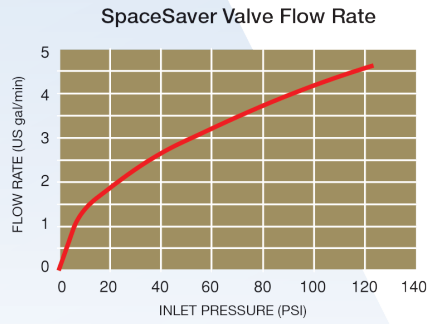

220P Series Medium Trough Valve

The 220P acetyl plunger activated valve is designed for use with medium-sized troughs. It is an ideal solution for troughs with confined inlet compartments for connection to a hose or silencer tube.

- Working pressure 0 - 200psi
- Removable seat for lower pressures (tool included)
- Barbed outlet for cistern application
- Long tail – no tank fitting required



220P Series

| PART # | MODEL | SIZE | LIST |
|----------|--------|------|-------|
| 88005640 | 220P12 | 1/2" | 29.00 |
| 88005641 | 220P34 | 3/4" | 29.00 |
| 88005642 | 220P1 | 1" | 31.00 |



72 Series Brass Full Flow Trough Valve

Brass sleeve valve for fast filling medium troughs.

- Full flow design
- Robust brass body
- Fully serviceable



72 Series

| PART # | MODEL | SIZE | LIST |
|----------|----------|-----------|-------|
| 88005639 | 72 3/4-1 | 3/4" & 1" | 57.20 |

VSB Series Visi-Ball® Water Level Indicator

The Visi-Ball is a highly visible water level indicator suitable for all tanks and reservoirs. Utilizing an innovative uni-ball joint, the Visi-Ball indicator suits any tank installation regardless of roof pitch.

- Manufactured with high quality UV stabilized material and stainless steel
- Designed to withstand hard weather conditions
- Easily adjusted using patented Uni-Ball joint
- Suitable for all tanks and reservoirs
- Innovative Uni-Ball design suits all roof angles on all tank types
- Visible from long distance

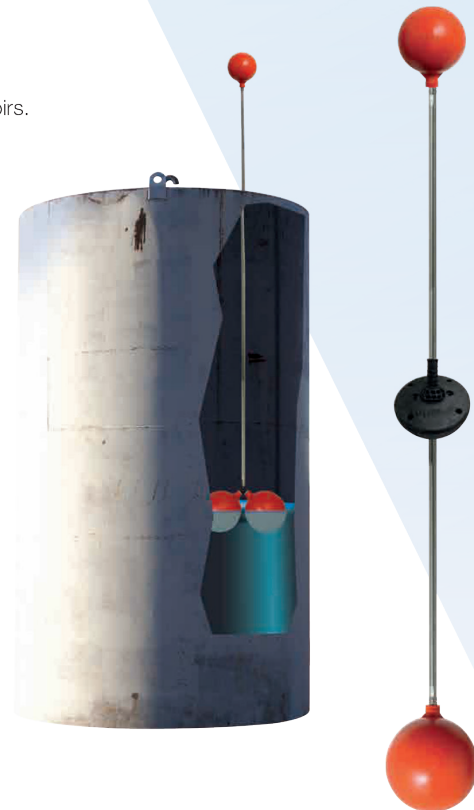

VSB Series

| PART # | MODEL | SIZE | LIST |
|----------|---------|----------------|--------|
| 88005645 | VSB | Visi-Ball | 228.00 |
| 88005646 | VSB-EXT | Extension Tube | 99.00 |

Heavy Duty Float Valves

Series 375, 500, 750, 1000, 1250, 1500 and 2000

(Heavy Duty Mechanical Float Valves with Threaded or Non-Threaded Outlets)

Heavy Duty Mechanical Float Valves are used in commercial, industrial, and agricultural applications for controlling high capacity water flow, and can be mounted on tank walls. The valves are constructed of a bronze body with a 1" to 2" (25 to 50mm) female NPT pipe threaded inlet connection and male straight-pipe threaded for locknut on the outlet side. It has serrated arms for easy adjustment of water level, bronze long and short arms, replaceable seals, and no-jam single lever action. This series is ideal for use in air conditioning, refrigeration, and irrigation systems.

Maximum Pressure: 165psi (11.4 bar).

For technical specifications refer to ES-HDV on watts.com.

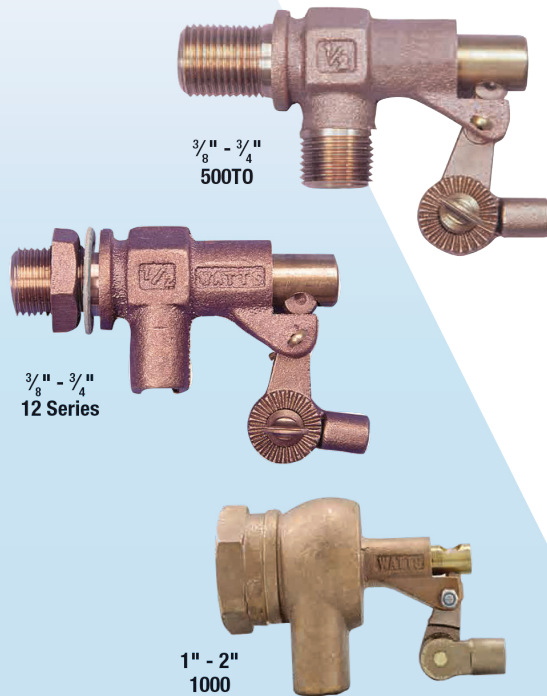

Standard Duty Float Valve

Standard Duty

Brass valves with threads on both ends.

(For other sizes consult factory.)

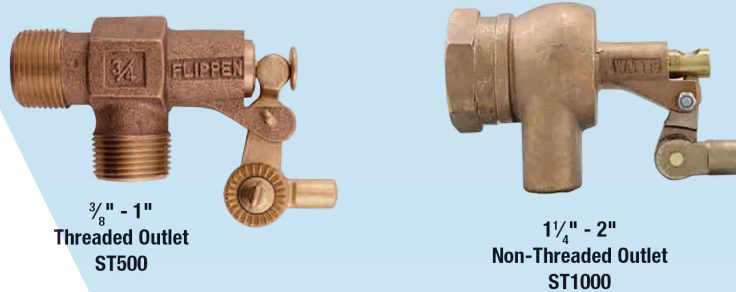

Heavy Duty Floats

CX Series Copper Heavy Duty Floats

Composed of high grade copper construction and feature firmly bonded overlapping joints.

PX Series Plastic Heavy Duty Floats

These non-electrolytic and highly corrosion resistant floats are ideal for use with salts and caustic fluids. Composed of injection-molded polyethylene, they are resistant to sunlight and deterioration.

