

2024 WHEELLINE

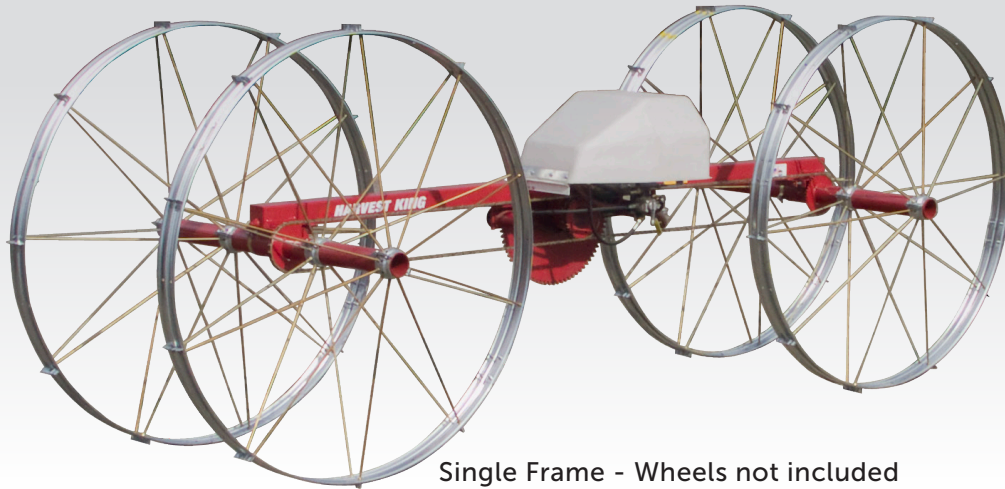



Single Frame - Wheels not included

GHEEN WHEEL LINE HYDRAULIC FRAME MOVERS

PART #	WHEEL LINE DESCRIPTION	LENGTH	ENGINE/OIL	WEIGHT	LIST
Single Rail Frame					
600-HK	Harvest King Lake# 730342	Single Frame - Red Paint Western Style Mover	12'	8 hp Briggs Horizontal Frame Based Oil Tank	410 7,274.65
600-CK	Crop King Lake# 730090	Single Frame - Blue Paint	12'	10.5 hp Briggs Vertical Frame Based Oil Tank	425 7,274.65
600-FK	Field King Gheen# 2354-G	Single Frame - Galvanized Western Style Mover	12'	6 hp Honda Horizontal Mounted Oil Tank	435 7,274.65
Dual Rail Frames					
600-DK	Dual King Lake# 730341	Dual Frame - Blue Painted	15'	10.5 hp Briggs Vertical Mounted Oil Tank	475 8,122.40
600-RK	Ranch King Gheen# 2355-G	Dual Frame - Galvanized	15'	8 hp Briggs Horizontal Mounted Oil Tank	545 8,122.40



Dual Frame - Wheels not included

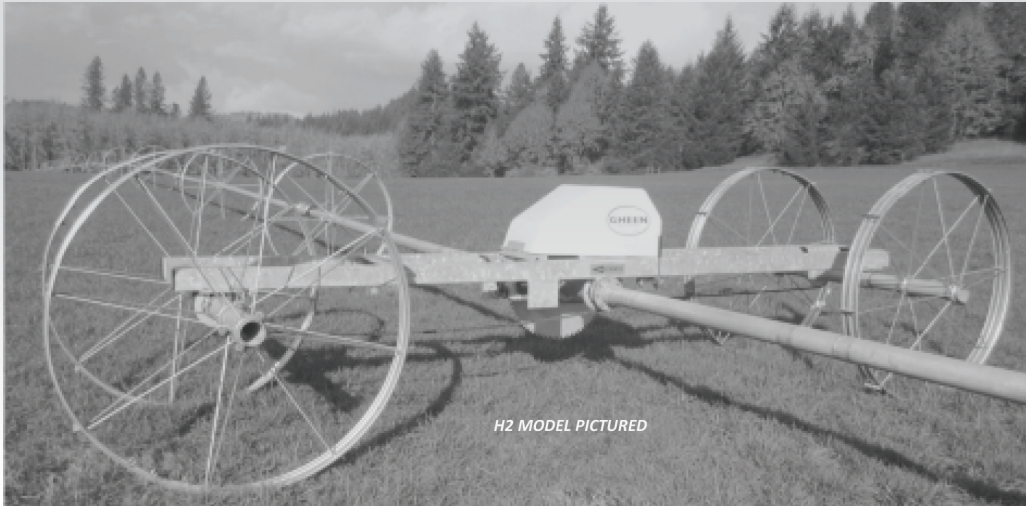

H2 MODEL PICTURED

GHEEN WHEEL LINE HYDROSTATIC DUAL FRAME MOVERS

PART #	WHEEL LINE DESCRIPTION	LENGTH	ENGINE/OIL	WEIGHT	LIST
600-H1	Gheen H1 Style Dual Frame - Galvanized Gheen# 2356-G Variable Speed Control, Peerless Axle and Gear Drive Train	15'	6 hp Honda Horizontal	650	9,849.45
600-H2	New H2 Style Dual Frame - Galvanized New Clean Design, Variable Speed Control, Belt Drive Train and available w/electric start	15'	6 hp Honda Vertical	642	9,849.45



Ships Unassembled

COMPLETE WHEELS

PART#	WHEEL HUB	DIAMETER	WEIGHT	LIST
6313-54	5' 4"	58"	37	Call
6313-55	5' 5"	58"	37	
6313-64	6' 4"	64"	39	
6313-65	6' 5"	64"	39	
6313-74	7' 4"	76"	51	
6313-75	7' 5"	76"	51	



WHEEL RIM

PART #	SIZE	DIAMETER	WEIGHT	LIST
6313R-5	5'	58"	7.8	Call
6313R-6	6'	64"	8.7	
6313R-7	7'	76"	10.2	

2 per wheel

WHEEL SPOKE

PART #	WHEEL	HUB	LENGTH	WEIGHT	LIST
6313S-54	5'	4"	27 1/4"	.83	Call
6313S-55	5'	5"	26 7/8"	.81	
6313S-6	6'	4/5"	30 1/2"	.91	
6313S-7	7'	4/5"	37"	1.11	

5' and 6' require 16 each, 7' require 20 each



WHEEL HUB

PART #	SIZE	LIST
6313H-4	4" 9 hole	Call
6313H-5	5" 9 hole	

4 per wheel



WHEEL CLEAT

PART #	LIST
6313C	Call

5' and 6' require 8 each, 7' require 10

AXLES & BEARINGS

PART #	LIST
Call for Pricing and Availability	



WHEEL LINE PARTS



FLANGE ADAPTERS

PART #	SIZE	# HOLE	OD	BCD	BHD	LIST
694-4R	4"	8	7 1/2"	6 1/4"	7/16"	80.90
694-5R	5"	8	7 1/2"	6 1/4"	7/16"	86.25
670-4R	4"	6	7 3/4"	6 3/4"	9/16"	91.10
670-5R	5"	6	7 3/4"	6 3/4"	9/16"	97.25
694-6x8	6 Hole x 8 Hole Flange Adapter					120.00
694-BK	8 Hole Bolt Kit					12.50
670-BK	6 Hole Bolt Kit					10.00



FLANGE ADAPTERS

PART #	DESCRIPTION	LIST
694-MF	Western Type Male Coupler x 8 Hole Flange	185.95
694-FF	Western Type Female Coupler x 8 Hole Flange	143.95
658-4TDF	Internal Drain Male x 6 Hole Flange	161.70
658-5TDF	Internal Drain Female x 6 Hole Flange	203.30
Includes Drain, Gaskets and Bolt Kit		
Flange Gaskets see page		
Drains see page		



LAKE WESTERN STYLE TORQUE COUPLER SET

PART #	SIZE	OUTLET	DRAIN TYPE	LIST
730250	4"	3/4"	Flapper	127.30
730260	5"	3/4"	Flapper	141.70
730238	4"	1"	Flapper	127.30
730241	5"	1"	Flapper	141.70
730135	5"	1"	Mushroom	154.70
Includes Couplers, Quad Ring, Drain and Clamp.				
Coupler Gaskets see page				



Male

Female (Quad Ring Separate)

LAKE WESTERN STYLE COUPLERS

PART #	SIZE	OUTLET	DRAIN TYPE	LIST
730237	4" Male	3/4"	Flapper	63.85
730236	5" Male	3/4"	Flapper	68.10
730239	4" Male	1"	Flapper	63.85
730240	5" Male	1"	Flapper	68.10
730136	5" Male	1"	Mushroom	81.25
732132	4" Female	-	-	44.95
732137	5" Female	-	-	51.30

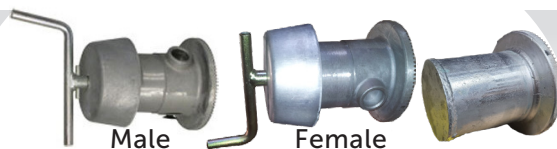

Male

Female

WESTERN STYLE END PLUGS

PART #	DESCRIPTION	LIST
693-40F	Female w/ Quad Ring	157.95
693-40M	Male with 1" Outlet, Mushroom Drains	157.95
693-EP	Non-Flushing Plug, No Outlet or Drain	129.95
693-SP	Splash Plate	22.85
693-SH	T-Handle and Stem	47.85



WESTERN STYLE CENTER FEED INLET TEE

PART #	DESCRIPTION	LIST
697-CFIT3	3" Crown Inlet with Quad Ring and Drain	305.00
697-CFIT4	4" Crown Inlet with Quad Ring and Drain	305.00
Hose Packs see page 8		
Valve Opener and Stubs see Handline Mainline Section pages 3, 4 & 11		

WHEEL LINE PARTS

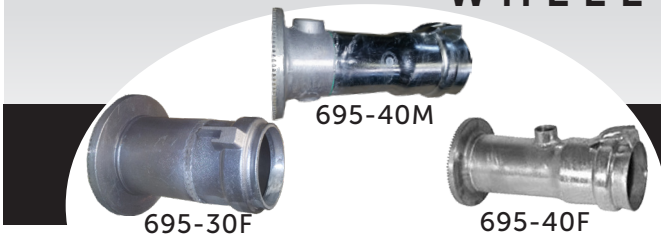

WESTERN STYLE HOSE ADAPTERS

PART #	INLET	DESCRIPTION	LIST
695-30M	3"	Male Coupler w/1" Outlet, No Drain	147.95
695-30F	3"	Female Coupler w/O-ring	144.00
695-40M	4"	Male Coupler w/1" Outlet, Drain	170.55
695-40F	4"	Female Coupler w/ 1" Outlet	156.75



TELESCOPE COUPLER AND SLIDE BAND

PART #	DESCRIPTION	LIST
623-35	3" Inlet x 4" Press In w/ 1" Outlet	110.45
623-36	4" Inlet x 5" Press In w/ 1" Outlet	142.90
623-37	3" T-Handle Slide Band w/ Hook	52.75
623-38	4" T-Handle Slide Band w/ Hook	72.45

HYDRAULIC PARTS



ORBIT MOTOR AND PARTS

PART #	DESCRIPTION	LIST
602-09	Orbit Motor K Style Char Lynn Eaton	585.00
602-09W	Orbit Motor K Style Gheen	420.00
602-09P	Orbit Motor P Style High Torque	Call
602-11	Orbit Motor Repair Kit -007 Series	90.75
602-12	Orbit Motor Repair Kit -005 Series	90.75
602-23	Orbit Motor Repair Kit -009 Series	102.55
602-09A	Face Plate Flange	140.65
602-MB	Flat Head Mounting Bolt	1.15
602-KEY	Shaft Key for Orbit Motor	1.75



HYDRAULIC PARTS

PART #	DESCRIPTION	LIST
602-15	Hydraulic Pump w/ 1/2" Shaft	234.40
602-25	Hydraulic Pump Mounting Bracket	67.70
602-13	Hydraulic Control Valve	200.00
602-29	Replacement Handle Assembly	27.40
602-20	Flat Hydraulic Oil Filter Complete	55.20
602-22	Replacement Screen for Flat Filter	18.25
602-18	Hydraulic Filter Spin On	20.00
602-18A	Filter Head Assembly	78.50
602-27	Oil Breather Cap	19.50



BAFSCO™ 4J COUPLERS

PART #	DESCRIPTION	LIST
602-01	1/2" Bore	10.00
602-02	5/8" Bore	10.00
602-03	3/4" Bore	10.00
602-08	7/8" Bore	10.00
602-04	1" Bore	10.00
602-05	4J EPDM Rubber Sleeve	8.85
602-07	5J EPDM Rubber Sleeve	40.00



HYDRAULIC HOSES

PART #	DESCRIPTION	LIST
6038-20	3/8" Swivel x 1/2" x 20" Long Discharge	32.00
6038-27	3/8" Swivel x 1/2" x 27" Long Discharge	35.00
6075-24	3/4" x 1/2" x 24" Long Suction	75.00
730022	3/8" x 1/2" Swivel x 14 3/8" Long	39.75
730151	1/2" x 3/4" x 17" Long	50.80
730026	1/2" x 1/2" Swivel x 18 1/2" Long	43.85
730335	1/2" x 3/4" x 35" Long	62.65



WHEEL LINE COUPLERS



Male

Female less O-ring

WHEEL LINE COUPLER SETS

PART#	SIZE	OUTLET	DRAIN TYPE	LIST
Western Type				
WMTFD4	4"	1"	Flapper	104.00
WMTFD5	5"	1"	Flapper	112.05
Round Type				
RWTC4-S	4"	1"	Spring Drain	107.94
RWTC5-S	5"	1"	Spring Drain	127.22
Square Type				
SWTC4-S	4"	1"	Spring Drain	105.50
SWTC5-S	5"	1"	Spring Drain	125.50

Includes Couplers, Gasket, Drain, Clamp & Press Bands

HEAT TREATED ALUM. WHEEL LINE TORQUE COUPLERS

PART#	SIZE	OUTLET	DRAIN TYPE	LIST
Western Type				
690-40	4" Female	-	-	26.90
690-50	5" Female	-	-	32.40
692-40	4" Male	1"	Flapper	38.70
692-50	5" Male	1"	Flapper	41.40



CLAMPS FOR TORQUE COUPLERS

PART#	DESCRIPTION	LIST
625-45	4" and 5" Western Type	24.28
6RLC	4" and 5" Internal Drain Type	18.68
625-47	4" Square Type w/Snap Pin	20.65
625-48	5" Square Type w/Snap Pin	22.90
914-52	Replacement Bail Spring for Ring Lock	5.25
625-49	Replacement Snap Pin	5.25



Female less Gasket

Male

INTERNAL DRAIN COUPLERS

PART#	SIZE	OUTLET	DRAIN TYPE	LIST
Round Type				
RWTC4	4" Male	-	-	32.60
RWTCB4	4" Female	1"	Spring	38.50
RWTC5	5" Male	-	-	38.78
RWTCB5	5" Female	1"	Spring	52.00



Female less Gasket

Male

SQUARE TORQUE COUPLERS

PART#	SIZE	OUTLET	DRAIN TYPE	LIST
Square Type				
SWTC4	4" Male	-	-	29.25
SWTCB4	4" Female	1"	Spring	45.40
SWTC5	5" Male	-	-	37.10
SWTCB5	5" Female	1"	Spring	54.70

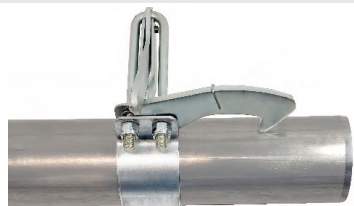

TELESCOPING SLIDE BAND

PART#	DESCRIPTION	LIST
TSB3	3" Slide Band	31.20



WHEEL LINE WHEELS

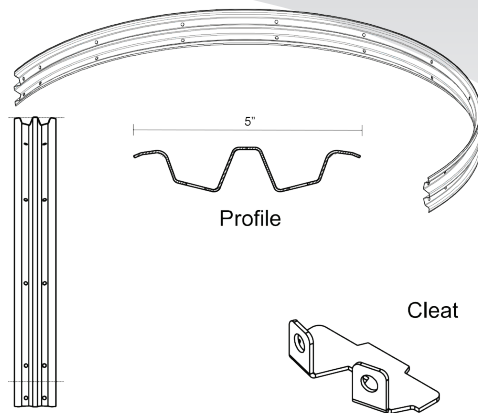
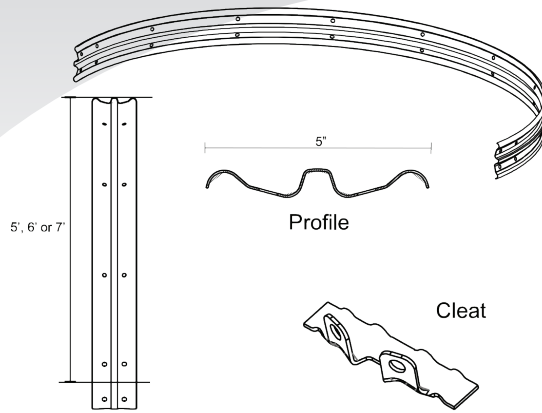

WESTERN, AM, GHEEN STYLE

PART #	DESCRIPTION	LIST
WLWR-WST58	58" (5') Wheel Half Rim	25.50
WLWR-WST64	64" (6') Wheel Half Rim	26.85
WLWR-WST76	76" (7') Wheel Half Rim	30.76
2 required per wheel		

WHEEL SPOKE

PART #	SIZE	HUB	LENGTH	# NEEDED	LIST
WLWS-26P	58"	5"	26 7/8"	16	3.42
WLWS-27P	58"	4"	27 1/4"	16	3.42
WLWS-30P	64"	4"/5"	30 1/2"	16	3.88
WLWS-37P	76"	4"/5"	37"	20	4.45

WESTERN STYLE WHEEL HUB

PART #	SIZE	LIST
WLWH-WST-4	4" 4 per wheel	5.79
WLWH-WST-5	5" 4 per wheel	5.79

WESTERN STYLE WHEEL CLEAT

PART #	SIZE	LIST
WLC-WST	5' and 6' require 8 each, 7' require 10	1.57

WHEEL COMPLETE (LESS BOLTS/NUTS)

PART #	SIZE	LIST
WLW-WST-58-4	58" (5') 4" Hub	141.44
WLW-WST-58-5	58" (5') 5" Hub	141.44
WLW-WST-64-4	64" (6') 4" Hub	151.50
WLW-WST-64-5	64" (6') 5" Hub	151.50
WLW-WST-76-4	76" (7') 4" Hub	189.38
WLW-WST-76-5	76" (7') 5" Hub	189.38
WLWBK	Bolt Kit, 16 Bolts & 56 Nuts	10.80

WADE STYLE

PART #	DESCRIPTION	LIST
WLWR-WD58	58" (5') Wheel Half Rim	26.50
WLWR-WD64	64" (6') Wheel Half Rim	27.27
WLWR-WD76	76" (7') Wheel Half Rim	31.61
2 required per wheel		

WHEEL SPOKE

PART #	SIZE	HUB	LENGTH	# NEEDED	LIST
WLWS-26P	58"	5"	26 7/8"	16	3.42
WLWS-27P	58"	4"	27 1/4"	16	3.42
WLWS-30P	64"	4"/5"	30 1/2"	16	3.88
WLWS-37P	76"	4"/5"	37"	20	4.45

WADE STYLE WHEEL HUB

PART #	SIZE	LIST
WLWH-WD-4	4" 4 per wheel	5.79
WLWH-WD-5	5" 4 per wheel	5.79

WADE STYLE WHEEL CLEAT

PART #	SIZE	LIST
WLC-WD	5' and 6' require 8 each, 7' require 10	1.57

WHEEL COMPLETE (LESS BOLTS/NUTS)

PART #	SIZE	LIST
WLW-WD-58-4	58" (5') 4" Hub	143.44
WLW-WD-58-5	58" (5') 5" Hub	143.44
WLW-WD-64-4	64" (6') 4" Hub	152.34
WLW-WD-64-5	64" (6') 5" Hub	152.34
WLW-WD-76-4	76" (7') 4" Hub	191.08
WLW-WD-76-5	76" (7') 5" Hub	191.08
WLWBK	Bolt Kit, 16 Bolts & 56 Nuts	10.80

DISCOUNTS ON ORDERS 300+

WHEEL LINE PARTS

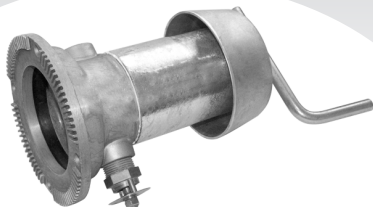

INTERNAL DRAIN END PLUGS

PART #	DESCRIPTION	LIST
659-5M	Male - No Outlet or Drain	167.80
659-50F	Female - w/ 1" Outlet and Drain	167.80



INTERNAL DRAIN HOSE ENDS

PART #	DESCRIPTION	LIST
658-30MH	3" Inlet x Male Coupler	188.50
658-30FH	3" Inlet x Female Coupler w/Gsk. and Drain	188.50
658-40MH	4" Inlet x Male Coupler	188.50
658-40FH	4" Inlet x Female Coupler w/Gsk. and Drain	188.50
658-40MHRO	4" Inlet x Male Coupler w/OUTLET	208.25



CENTER FEED INLET TEE

PART #	DESCRIPTION	LIST
670-CFIT3	3" RB Inlet with Gasket and Drain	331.10
670-CFIT4	4" RB Inlet with Gasket and Drain	331.10

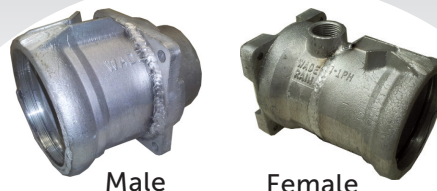

48 HOSE END ADAPTERS

PART #	DESCRIPTION	LIST
48-4-3PRF	3" Inlet Knob x 4" Female	175.15
48-4-3PRFH	3" Inlet Hook x 4" Female	175.15
48-4-3PRM	3" Inlet Knob x 4" Male	124.90
48-4-3PRMH	3" Inlet Hook x 4" Male	124.90
48-4-4PRF	4" Inlet Knob x 4" Female	224.65
48-4-4PRFH	4" Inlet Hook x 4" Female	224.65
48-4-4PRM	4" Inlet Knob x 4" Male	195.75
48-4-4PRMH	4" Inlet Hook x 4" Male	195.75
48-5-4PRF	4" Inlet Knob x 4" Female	238.85
48-5-4PRFH	4" Inlet Hook x 4" Female	238.85
48-5-4PRM	4" Inlet Knob x 5" Male	209.25
48-5-4PRMH	4" Inlet Hook x 4" Male	209.25

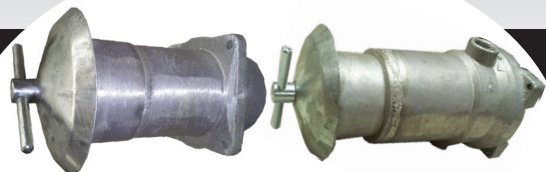

48 FLUSHING END PLUG

PART #	DESCRIPTION	LIST
49-4PRM	4" Male No Outlets	222.95
49-4PRF	4" Female w/ 1" Outlets	222.95
49-5PRM	5" Male No Outlets	229.25
49-5PRF	5" Female w/ 1" Outlets	229.25
29-4SP	Metal Splash Plate	13.85
10-4-5SS	T-Stem Screw	31.90

48 CENTER FEED INLET TEE

PART #	DESCRIPTION	LIST
2-4-4-48P	4" Inlet Knob x 4" Couplers	368.85
2-4-4-48PHL	4" Inlet Hook x 4" Couplers	368.85
2-5-4-48P	4" Inlet Knob x 5" Couplers	424.65
2-5-4-48PHL	4" Inlet Hook x 5" Couplers	424.65

48 IN-LINE REDUCER

PART #	DESCRIPTION	LIST
48-5-4R	5" Female x 4" Male	224.35
48-4-5R	5" Male x 4" Female	200.70
With Gasket and 1" Outlets		

WHEEL LINE PARTS



SIDEWINDER™ HOSE PACKS

PART #	DESCRIPTION	LIST	
6120-30	3" x 20' Male x Male	265.00	
6120-40	4" x 20' Male x Male	355.00	
6125-30	3" x 25' Male x Male	315.00	
6125-40	4" x 25' Male x Male	405.00	
	Bulk Hose	Cut/Ft	Roll/Ft
6100-30	3" x 100'	8.48	7.20
6100-40	4" x 100'	11.66	9.95
	Hook and Latch Hose Ends		
MHLHE3	3" Male	22.48	
MHLHE4	4" Male	37.60	
FHLHE3	3" Female	22.48	
FHLHE4	4" Female	37.60	



3/4" SELF LEVELER

PART #	DESCRIPTION	LIST
675	For Brass Impact (16 per box)	16.59
675-10	Rebuild Kit (Rebuilds 20)	48.00
	Qty. 20 each Rubber Washers, O-rings, Snap Rings, Retaining Washers and Qty. 40 Teflon Washers.	
	Universal Leveler Repair Components	
675-1	Snap Ring	1.00
675-2	Brass Washer	.60
675-3	O-Ring	.25
675-4	Teflon Washer	.35
675-5	Brass Spindle	8.00
675-6	Rubber Washer	.35
675-7	Stainless Steel Spring	1.00



NEW - WC75 REVERSIBLE

ROAD GUARD

PART #	DESCRIPTION	LIST
WC75	Screen Box Type	25.00



BAFSCO™ WHEEL LINE ELBOW

PART #	DESCRIPTION	LIST
75WR75	3/4" MPT x 3/4" FPT	5.25
100WR75	1" MPT x 3/4" FPT	6.00
75WR75T	3/4" x 3/4" for T-bird	7.90
100WR100	1" MPT x 1" MPT	8.35



PRESS BANDS

PART #	DESCRIPTION	LIST
124-40	4" Aluminum	3.55
124-50	5" Aluminum	3.75

Other sizes see Handline Mainline page 12



BAFSCO™ PIPE PRESSING PAINT

PART #	DESCRIPTION	LIST
888	Pressing Paint 24oz	24.00
889	Pressing Catalyst 8oz	10.75

Mix Ratio 3:1, Paint:Catalyst



REPAIR SLEEVES

PART #	DESCRIPTION	LIST
PRSL4	4" x 10"	15.00
PRSL5	5" x 10"	18.20

Other sizes see Handline Mainline page 12

WHEEL LINE PARTS



ENGINES

PART #	BRAND	HP	SHAFT	WT	LIST
680-65	Bafsc0	7	3/4" Horizontal	32#	350.00
670-5.5V	Honda	6	7/8" Vertical	30#	1,239.60
670-6.5H	Honda	6	3/4" Horizontal	35#	1,093.75
670-8.0	Briggs	8	1" Horizontal	40#	1,093.75
670-10.5	Briggs	10.5	1" Vertical	65#	1,300.00

HOODS AND HINGE KITS

PART #	DESCRIPTION	LIST
685-LAKE	White Poly Hood for Crop, Harvest, Dual King & H2	255.10
685-WEST	Red Poly Hood fits Field and Ranch King	453.65
685-DUAL	Red Poly Hood for Hydrostatic Mover	453.65
686-LAKE	Hinge Kit	85.00
686-WEST	Hinge Kit	108.20

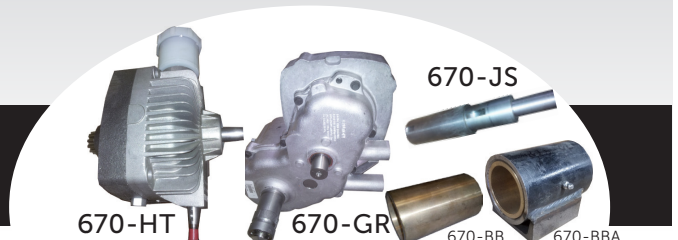

GEARS

PART #	DESCRIPTION	LIST
Western		
602-10	7 Tooth Pinion Gear for Orbit Motor	36.80
730015	Bull Gear 82 Tooth 8 Hole Pattern	598.95
Hydrostatic		
670-PG	Pinion Gear End of Reduction Unit	115.00
670-60TG	Jack Shaft 60 Tooth Pinion Gear	385.00
670-MPG	Jack Shaft Main Pinion Gear to Bull Gear	125.00
56-01-1	Bull Gear 82 Tooth 6 Hole Pattern	598.95
Wade 70 Series		
70-105713	Output Gear for Transmission	108.05
70-396-1	Gear 45 Tooth (for 57" Wheels)	432.20
70-395-20	Sprocket 48 Tooth 5.015" Bore	64.10
70-396-15	Bearing Tailwheel Model 70	143.45

HYDROSTATIC PARTS

PART #	DESCRIPTION	LIST
670-JS	Jack Shaft	142.50
670-BB	Bronze Bushing 4" x 2"	147.10
670-BBA	Jack Bushing Assembly	195.80
670-HT	Transmission	1,510.00
70-11	Transmission Fan	58.65
70-408	Fan Guard	48.70
70-10351	Transmission Cap Only	20.00
670-GR	Gearbox Reduction Unit	1,510.00
70-402-7	McGill Bearing Model 70	93.95
70-485	Shift Lever Linkage Weldment	20.00
70-486	Shift Lever Handle	31.50
70-488	Complete Shift Lever Assembly	125.00
More parts please call		

BAFSCO™ NICKEL PLATED ROLLER CHAIN



BAFSCO™ PLATED ROLLER CHAIN

PART#	WHEELINE	DESCRIPTION	PLATING	LENGTH	BOX QTY	#/BOX	LIST/EA
Fits Hydraulic							
650-131	Western	A2050 131 Pitch w/Off and Conn. Link	Nickel	13'8"	10	67	50.00
650Z-131	Western	A2050 131 Pitch w/Off and Conn. Link	Zinc	13'8"	10	67	69.45
650-154	Travis Twin	A2050 154 Pitch w/Connecting Link	Nickel	16'	10	78	58.45
650-169	Dual King	A2050 169 Pitch w/Off and Conn. Link	Nickel	17'7"	10	84	65.65
650-28	Conversion	A2050 28 Pitch w/Connecting Link	Nickel	2'10"	1	1.4	11.25
Fits Hydrostatic							
650-158	Wade 70	A2050 158 Pitch w/Connecting Link	Nickel	16'6"	10	80	58.00
650Z-158	Wade 70	A2050 158 Pitch w/Connecting Link	Zinc	16'6"	10	80	83.05
650-159.5	Wade 47	A2050 159 Pitch w/#50 Conn. Link	Nickel	16'8"	10	82	63.10
Fits Thunderbird							
640-214	Transmission	A2040 214 Pitch w/Connecting Link	Nickel	17'10"	10	50	46.15
640-58		#40 58 Pitch w/Connecting Link	Nickel	2'5"	50	50	8.30
640-60		#40 60 Pitch w/Connecting Link	Nickel	2'6"	50	53	8.55
635-48		#35 48 Pitch w/Connecting Link	Nickel	1'6"	1	.35	4.85
660-79		#60 79 Pitch w/Off and Conn. Link	Nickel	4'11"	10	50	37.80
Bulk							
650-100		A2050 100' Roll w/10 Conn. Links	Nickel	100'	1	50	365.00
650Z-100		A2050 100' Roll w/10 Conn. Links	Zinc	100'	1	50	500.00
640-100		A2040 100' Roll w/10 Conn. Links	Nickel	100'	1	31	262.50
Links							
650-11		A2050 Connecting Link	Nickel		25		1.85
650Z-11		A2050 Connecting Link	Zinc		50		1.60
650-12		A2050 Offset Link	Nickel		50		3.70
650Z-12		A2050 Offset Link	Zinc		50		3.10
640-11		A2040 Connecting Link	Nickel		50		1.35
640-12		A2040 Offset Link	Nickel		50		2.10
635-11		#35 Connecting Link	Nickel		50		.65
635-12		#35 Offset Link	Nickel		50		1.20
640-13		#40 Connecting Link	Nickel		50		1.00
640-14		#40 Offselt Link	Nickel		50		1.60
650-13		#50 Offset Link	Nickel		50		2.10
650-14		#50 Connecting Link	Nickel		50		1.10
660-13		#60 Offset Link	Nickel		50		2.20
660-14		#60 Connecting Link	Nickel		50		1.20
650-CB		Chain Breaker used to cut #25-#60 Riveted Roller Chain			1		22.35

WHEEL LINE GASKETS

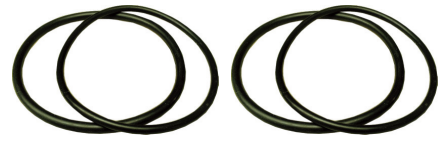

FLANGE ADAPTERS GASKETS

PART #	FITS	ID	OD	HOLES	LIST
600-01	Farmland/Redi Rain	4"	6"	8	5.15
600-02	Farmland/Funk	4"	6"	9	5.15
600-03	Gheen 4" #2314	4"	7"	5	5.15
600-04	Western/Universal	5"	7"	8	5.15
600-05	Decoto/Redi Rain	5"	7"	10	5.15
600-06	Wade 4" or 5"	5"	7 3/4"	6	5.15
600-07	Gheen 5" #2314	5"	8"	6	5.15
600-08	Gheen 6" #2314	6"	9"	6	8.00

O-RING GASKETS

PART #	FITS	ID	C.S.	LIST
603-02	Alumax/Teledyne	4 1/2"	1/4"	1.25
603-03	Ireco/Pierce/MooreRane	4 3/4"	3/16"	1.10
603-04	4" Moore Rane	3 7/8"	3/16"	1.10
603-05	5" Moore Rane/Pierce	4 3/4"	1/4"	1.50
603-06	ShurRane&Roll/Trunnel	5 3/8"	1/4"	1.75
603-07	Western	4 1/2"	3/16"	1.00
603-08	Old Style A & M	4"	3/16"	1.10
603-14	Ireco Speed Roll	4 3/8"	3/16"	1.10



WADE TYPE POWERROLL "FAST"

PART #	DESCRIPTION	LIST
603-40	Fits 4" 48 Series Coupler	2.80
603-45	4 1/2" Fits 4" & 5" 58 Series Coupler	3.35
603-50	Fits 5" 48 Series Coupler	4.30

QUAD RING, U-RING AND HALF GASKETS

PART #	FITS	ID	C.S.	LIST
603-10	Trunnell Old Style Steel	4 1/4"	1/4"	2.10
603-11	Crown, Gheen, Lake	4 1/2"	1/4"	2.00
603-12	Ireco Speed Roll	4 3/8"	3/16"	2.10
603-13	Trunnell Stell/Shur Roll	5 1/4"	1/4"	2.90
603-16	U-Shape AB5G/Ireco/RR	4 5/8"	3/16"	2.15
603-17	Half Round Ireco/Redi-R	4 5/8"	3/16"	2.25



WESTERN/RAINWAY INTERNAL DRAIN TYPE GASKET

PART #	DESCRIPTION	LIST
603-29	4 1/2" I. D.	3.25



SEAL RINGS

PART #	DESCRIPTION	LIST
452-40	4" Decoto & T-Bird Seal Ring	2.10
452-50	5" Decoto & T-Bird Seal Ring	4.95
445-40	4" Gheen Chainlock (Stout Seal Ring)	2.70
445-50	5" Gheen Chainlock (Stout Seal Ring)	4.00

ALUMAX "NEW STYLE"

PART #	DESCRIPTION	LIST
603-01	4 1/2" ID x 1/4" A&M Square	4.25



PART #	DESCRIPTION	LIST
604-01	3M™ Scotch Grip Adhesive	16.65



AUTOMATIC DRAINS



DRAIN FAST™ FLAPPER DRAIN

PART #	DESCRIPTION	LIST
601-01	Complete Flapper Drain	6.82
601-02	Rubber Flapper	2.00
601-03	Threaded Insert	1.94
601-05	Splash Nut	2.88
3-piece Design Eliminates Need for Jam Nut		



SPRING DRAIN™

PART #	DESCRIPTION	LIST
601-07	1" Spring Drain Complete	10.16
601-15	Splash Plate	.70
601-16	Spring	.90
601-17	Plunger	3.35
601-19	Rubber Washer	.55



Z-DRAIN™ CONVERTS MUSHROOM TO STAR DRAIN

PART #	DESCRIPTION	LIST
601-30	7/8" Plastic Drain	13.34
ZDBASE	Plastic Base	4.46
601-12	Metal Cap	6.00
601-08	Rubber Star	.80



V-DRAIN™

PART #	DESCRIPTION	LIST
601-20	1" Plastic Drain	11.48
601-10	Plastic Base	4.68
601-12	Metal Cap	6.00
601-08	Rubber Star	.80



STAR DRAIN™

PART #	DESCRIPTION	LIST
601-22	1" Star Drain	11.74
601-11	Metal Base	4.94
601-12	Metal Cap	6.00
601-08	Rubber Star	.80



601-18



601-25



DP75



601-150

DRAINS

PART #	DESCRIPTION	LIST
601-18	Shur Roll Type Drain Valve	3.10
601-25	Flapper Drain Nut & Washer Conversion	6.30
601-26	Rubber Washer	1.00
DP75	3/4" Expandable Plug	2.30
DP875	7/8" Expandable Plug	2.50
601-150	1 1/2" Low Pressure Drain Valve	41.85



101-17

101-13

101-16

101-12



MUSHROOM DRAINS AND CLIPS

PART #	DESCRIPTION	LIST
101-11	Kobby Mushroom Drain Valve (Fast)	1.55
101-12	Mushroom Drain Valve (No Bumps)	1.55
101-13	Concave Drain Valve Long Shank	1.30
101-15	Mushroom Clip Plated	.55
101-16	Double Headed H P Drain Valve	1.40
101-17	Mushroom Clip Plastic	.40

REDI-RAIN WHEEL LINE PARTS



REDI RAIN PRESS IN COUPLERS

PART #	SIZE	LIST
WMSC-4F	4" Female	
WMSC-5F	5" Female	



REDI RAIN PRESS IN COUPLERS

PART #	SIZE	LIST
WMC-4M	4" Male	
WMC-5M	5" Male	



REDI RAIN COMPLETE COUPLER

PART #	SIZE	LIST
WMC-4	w/ Spring Drain	
WMC-5	w/ Spring Drain	
DVB	Spring Drain	



REDI RAIN CLAMPS

PART #	SIZE	LIST
625-40	WFC-4 4"	
625-50	WFC-5 5"	



REDI RAIN END PLUGS

PART #	DESCRIPTION	LIST
WFP-4	4" Flush Plug	
WFP-5	5" Flush Plug	

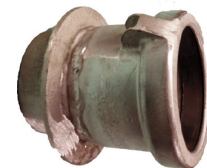

REDI RAIN HOSE ENDS

PART #	SIZE	LIST
WMA-4x3	4" x 3" Hose	
WMA-4x4	4" x 4" Hose	
WMA-5x5	5" x 5" Hose	
WMA-5x4	5" x 4" Hose	



POWER MOVE AXLE COUPLER

PART #	SIZE	LIST
PMAC-5x4	5" x 4"	
PMAC-5x5	5" x 5"	
600-05	Flange Gsk. 10 Hole	5.15



ALUMINUM HOSE ENDS

PART #	SIZE	LIST
627A-30	3" Male Alum.	
627A-40	4" Male Alum.	



REDI RAIN DRAGLINE

PART #	DESCRIPTION	LIST
601-09	Trail Line Button Drain	2.15
601-19	1 1/4" Trail Line Gasket	1.65
603-21	5" Flat Gasket	3.00